

MUNICIPAL SERVICES SPECIFICATIONS MANUAL



West Hants
something inspiring awaits

REVISION DATE: October 24, 2023

TABLE OF CONTENTS

| | | |
|---------|---|----|
| 1.0 | Introduction / General Requirements..... | 1 |
| 2.0 | Definitions | 4 |
| 3.0 | Submission Requirements..... | 9 |
| 3.1 | Concept Plan Approval..... | 9 |
| 3.2 | Tentative Plan Approval..... | 9 |
| 3.2.1 | Survey Plan and Application..... | 9 |
| 3.2.2 | General Service Plan..... | 10 |
| 3.2.3 | N.S. Department of Environment and Climate Change Permit to Construct | 10 |
| 3.2.4 | Other Permits | 10 |
| 3.2.4.1 | Sanitary Sewer Systems..... | 10 |
| a) | General..... | 10 |
| b) | Gravity Systems..... | 10 |
| c) | Pump Station and Force Main..... | 10 |
| 3.2.4.2 | Water Systems | 11 |
| 3.2.4.3 | Storm Drainage Systems..... | 11 |
| 3.2.4.4 | Municipal Streets..... | 12 |
| 3.3 | Final Plan Approval Submission Requirements..... | 13 |
| 3.3.1 | Close Out Report | 13 |
| 3.3.1.1 | General | 13 |
| 3.3.1.2 | Survey Plan and Application (Section A of the Close Out Report)..... | 13 |
| 3.3.1.3 | Certification of Compliance (Section B of the Close Out Report) | 13 |
| 3.3.1.4 | Maintenance Bond (Section C of the Close Out Report) | 14 |
| 3.3.1.5 | Plan of Streets, ROW's, and Easements (Section D of the Close Out Report) | 14 |
| 3.3.1.6 | Deeds and Easement Documentation (Section E of the Close Out Report) | 14 |
| 3.3.1.7 | Operation and Maintenance Manuals (Section F of the Close Out Report)..... | 14 |
| 3.3.1.8 | Inspection and Testing Reports (Section G of the Close Out Report)..... | 14 |
| a) | Water, Sanitary, and Storm Systems..... | 14 |
| b) | Road Systems | 15 |
| 3.3.1.9 | Record Drawings (Section H of the Close Out Report) | 15 |

| | | |
|---------|--|----|
| 3.3.2 | Alternative to Complete Construction and Acceptance Prior to Final Approval..... | 15 |
| 3.3.2.1 | Street Completion Agreement..... | 15 |
| 3.3.2.2 | Performance Surety..... | 16 |
| 4.0 | Municipal Street Design | 17 |
| 4.1 | Scope..... | 17 |
| 4.2 | Geometric Design Specifications..... | 17 |
| 4.2.1 | General | 17 |
| 4.2.1.1 | Design Standards | 17 |
| 4.2.2 | Right-of-Way..... | 17 |
| 4.2.2.1 | Minimum Widths..... | 17 |
| 4.2.2.2 | Cut and Fill Slopes..... | 18 |
| 4.2.2.3 | Acceptable Access for Adjacent Properties / Road Reserves | 18 |
| 4.2.3 | Road Layout..... | 18 |
| 4.2.3.1 | General | 18 |
| 4.2.3.2 | Cul-de-Sacs..... | 19 |
| 4.2.3.3 | Grassed Boulevards | 19 |
| 4.2.3.4 | Guard Rail | 19 |
| 4.2.4 | Intersections..... | 19 |
| 4.2.4.1 | Intersections with Provincial Highways | 19 |
| 4.2.4.2 | Intersections with Local Roads | 19 |
| 4.2.4.3 | Offset Intersections | 19 |
| 4.2.5 | Vertical Alignment..... | 20 |
| 4.2.5.1 | Grades..... | 20 |
| 4.2.5.2 | Vertical Curves | 20 |
| 4.2.6 | Horizontal Alignment..... | 20 |
| 4.3 | Walkways and Sidewalks..... | 21 |
| 4.3.1 | Walkways..... | 21 |
| 4.3.2 | Sidewalks | 21 |
| 4.4 | Road Construction..... | 22 |
| 4.4.1 | Construction Season..... | 22 |
| 4.4.2 | Municipal Inspections..... | 22 |
| 4.4.3 | Construction Requirements..... | 22 |
| 4.5 | Installation of a Driveway Entrance on a Municipal Road | 23 |

| | | |
|----------|--|----|
| 5.0 | Storm Water Drainage Design..... | 24 |
| 5.1 | Scope..... | 24 |
| 5.2 | Design Approach..... | 24 |
| 5.2.1 | Storm Drainage Systems..... | 24 |
| 5.2.2 | Downstream Drainage Systems..... | 24 |
| 5.2.3 | Design Storm Frequencies..... | 25 |
| 5.2.3.1 | Minor Systems..... | 25 |
| 5.2.3.2 | Major Systems..... | 25 |
| 5.2.4 | Foundation Drains..... | 25 |
| 5.2.5 | Roof Drains..... | 25 |
| 5.2.6 | Institutional, Commercial, and Industrial Connections..... | 25 |
| 5.2.7 | Connections to Public Property..... | 25 |
| 5.3 | Meteorological Data..... | 25 |
| 5.4 | Design Methodology..... | 26 |
| 5.4.1 | Rational Method..... | 26 |
| 5.4.2 | SCS Methods..... | 26 |
| 5.4.3 | Storage Facilities..... | 26 |
| 5.5 | Design Requirements..... | 26 |
| 5.5.1 | Location..... | 26 |
| 5.5.2 | Discharge to Adjacent Properties..... | 27 |
| 5.5.3 | Buried Storm Drainage Systems..... | 27 |
| 5.5.3.1 | General..... | 27 |
| 5.5.3.2 | Velocities..... | 27 |
| 5.5.3.3 | Pipe Size..... | 27 |
| 5.5.3.4 | Pipe Material..... | 27 |
| 5.5.3.5 | Depths..... | 28 |
| 5.5.3.6 | Manholes..... | 28 |
| 5.5.3.7 | Service Laterals..... | 28 |
| 5.5.3.8 | Catch Basins..... | 28 |
| 5.5.3.9 | Inlets..... | 29 |
| 5.5.3.10 | Outfalls..... | 29 |
| 5.5.4 | Ditches / Open Channel Drainage System..... | 29 |
| 5.5.4.1 | Ditches..... | 29 |

| | | |
|----------|--|----|
| 5.5.4.2 | Velocities..... | 29 |
| 5.5.4.3 | Culverts..... | 29 |
| 5.5.5 | Headwalls & Grates | 30 |
| 5.5.6 | Detention Structures | 30 |
| 5.5.6.1 | Design Volume | 30 |
| 5.5.6.2 | Inlet & Outlet | 30 |
| 5.5.6.3 | Flow Control Structures..... | 30 |
| 5.5.6.4 | Low Flow Channel..... | 31 |
| 5.5.6.5 | Emergency Overflow..... | 31 |
| 5.5.6.6 | Maximum Side Slopes..... | 31 |
| 5.5.6.7 | Minimum Bottom Slope..... | 31 |
| 5.5.6.8 | Fencing..... | 31 |
| 5.5.6.9 | Access Road | 31 |
| 5.5.6.10 | Stormwater Inline Storage..... | 32 |
| 5.6 | Lot Plans for Building Permit..... | 32 |
| 5.7 | Erosion and Sedimentation Control..... | 32 |
| 6.0 | Sanitary Sewage System Design..... | 33 |
| 6.1 | Scope..... | 33 |
| 6.2 | Design Requirements | 33 |
| 6.2.1 | Gravity Systems | 33 |
| 6.2.1.1 | General | 33 |
| 6.2.1.2 | Pipe | 34 |
| 6.2.1.3 | Hydraulic Design | 34 |
| 6.2.1.4 | Minimum Pipe Size | 34 |
| 6.2.1.5 | Minimum Slope..... | 34 |
| 6.2.1.6 | High Velocity Protection | 34 |
| 6.2.1.7 | Depth | 34 |
| 6.2.1.8 | Location | 35 |
| 6.2.1.9 | Alignment..... | 35 |
| 6.2.1.10 | Manholes..... | 35 |
| 6.2.1.11 | Service Laterals..... | 36 |
| 6.2.2 | Pumped Systems | 37 |
| 6.2.2.1 | General | 37 |

| | | |
|---------|---|----|
| 6.2.2.2 | Private Pumps | 37 |
| 6.2.2.3 | Joints | 37 |
| 6.2.2.4 | Groundwater Movement | 37 |
| 6.2.2.5 | Pumping Stations | 38 |
| a) | Wet Well Size | 38 |
| b) | Pump Manufacturers | 38 |
| c) | Emergency Overflows | 38 |
| d) | Safety Precautions..... | 39 |
| e) | Phased Development | 39 |
| f) | Pump Selection | 39 |
| g) | Surcharge | 39 |
| h) | Flow Velocities | 40 |
| i) | Piping..... | 40 |
| j) | Inlet Arrangements | 40 |
| k) | Hydraulic Analyses | 40 |
| l) | Valves | 40 |
| m) | Wet Well Ventilation..... | 40 |
| n) | Access and Removal | 41 |
| o) | Pumping Arrangements | 41 |
| p) | Electrical | 41 |
| q) | Site Considerations | 42 |
| r) | Operations and Maintenance Manual | 43 |
| 6.2.2.6 | Force Main | 43 |
| a) | Pipe..... | 43 |
| b) | Valves | 43 |
| c) | Limiting Velocities | 43 |
| d) | Minimum/Maximum Depths | 43 |
| e) | Slope..... | 44 |
| f) | Location..... | 44 |
| g) | Termination..... | 44 |
| h) | Changes in Direction | 44 |
| 7.0 | Water Distribution System Design | 45 |
| 7.1 | Scope | 45 |

| | | |
|--------|--|----|
| 7.2 | Design Requirements | 45 |
| 7.2.1 | System Requirements..... | 45 |
| 7.2.2 | Minimum / Maximum Pressure..... | 46 |
| 7.2.3 | Pipe | 46 |
| 7.2.4 | Limiting Velocities..... | 47 |
| 7.2.5 | Looping | 48 |
| 7.2.6 | Minimum Sizes | 48 |
| 7.2.7 | Over Sizing | 48 |
| 7.2.8 | Minimum / Maximum Cover | 48 |
| 7.2.9 | Location | 48 |
| 7.2.10 | Valves..... | 49 |
| 7.2.11 | Trench Drainage Relief Systems | 49 |
| 7.2.12 | Changes in Direction..... | 50 |
| 7.2.13 | Fire Hydrants | 50 |
| 7.2.14 | Air Relief and Vacuum Valves | 50 |
| 7.2.15 | Service Lateral | 51 |
| 7.2.16 | Water Meter Chamber | 51 |
| 7.2.17 | Backflow Prevention Devices | 51 |
| 8.0 | Standard Details | 52 |
| | Appendix A – Sample Statutory Declaration..... | 53 |
| | Appendix B – Sample Street Completion Agreement..... | 54 |
| | Appendix C – Sample Letter of Credit..... | 55 |
| | Appendix D – Sample Close-Out Report Checklist | 56 |
| | Appendix E – Rainfall Data..... | 57 |
| | Appendix F – Standard Details | 58 |

1.0 INTRODUCTION / GENERAL REQUIREMENTS

This document has been prepared for use with and shall be read in conjunction with the "Standard Specification for Municipal Services" as published by the Nova Scotia Road Builders Association (NSRBA), the Nova Scotia Consulting Engineers Association (CENS), and the Joint Committee on Contract Documents (JCCD). In case of discrepancy, the more stringent requirement shall apply.

These design standards and guidelines have been prepared for setting minimum design and construction standards for Municipal Services Systems within the West Hants Regional Municipality (Municipality); to list and suggest limiting values for infrastructure to be conveyed to the Municipality; and to establish uniformity of practice in the Municipality. A complete documentation of all parameters relating to the design and construction of municipal services is beyond the scope of this document, however, an attempt has been made to touch upon the parameters of greatest importance and to present the policies and accepted procedures of the Municipality.

This Municipal Services Systems Specifications Manual (Specifications) shall apply to all proposed developments and infrastructure renewal projects proposing municipal sanitary sewer, water, storm drainage systems, and municipal streets.

The purpose of this document is to provide guidance for Design Engineers in the provision of Municipal Services Systems which meet these criteria, and are also consistent with cost effective installation, operation, and maintenance. The design of these services, when submitted to the Municipality must be under the seal of a Professional Engineer in accordance with the Engineering Profession Act. R.S., c. 148, s. 1.

This document is not intended to eliminate the necessity for detailed design, rather it is intended to provide minimum standards for the materials, design criteria, and method of construction to be utilized in the installation of municipal services systems. Further, it is not the intention of the Municipality to stifle innovation. Where, in the judgment of the Design Engineer, variations from this document are justified or required and where the Design Engineer can show that alternate approaches can produce the desired results, such approaches will be considered for approval. In considering requests for variations from these design criteria, the Municipal Engineer, or designate, shall take into consideration such factors as safety, nuisance, system maintenance, capital costs, operational costs, life cycle costs, environmental issues, and natural topography. All approved variances to these design criteria shall be provided in writing to the Development Officer.

Notwithstanding the consideration for approval from the Municipal Engineer, all Municipal Services Systems designed shall comply with the latest editions of the Atlantic Canada Guidelines for the Supply, Treatment, Storage, Distribution, and Operation of Drinking Water Supply Systems, the Atlantic Canada Guidelines Manual for the Collection, Treatment, and Disposal of Sanitary Sewage and they shall have all approvals to construct necessary from the Nova Scotia Department of the Environment and Climate Change (NSECC). All road connections to provincial roads or highways shall comply with the Nova Scotia Department of Public Works (NSDPW - previously Nova Scotia Department of Transportation & Infrastructure Renewal) "Specifications for Subdivision Roads in Urban and Rural Areas". The most stringent requirements shall prevail.

Each submission shall be accompanied by a statement from a Professional Engineer that the submission is in accordance with these Specifications except, if there are requested variations, the Design Engineer shall indicate clearly, in all appropriate documents and plans included with the submission, the specific variances from the design standards identified in these Specifications. Also, where the Design Engineer uses standards other than those outlined in this document, all appropriate documents and plans shall clearly indicate those areas of difference.

Acceptance by the Municipality of the design of proposed Municipal Services Systems does not relieve the Design Engineer of the responsibility for proper design, nor does it imply that the Municipality has checked the design exhaustively for compliance with this document. The Design Engineer retains full responsibility and liability for their work as a Professional Engineer. Where the Municipality has accepted a design which does not comply with these standards and where the Design Engineer has not brought variations from this document to the attention of the Municipal Engineer, the provisions of this document still stand.

All service systems shall conform to this document as well as any more stringent requirements established by other authorities having jurisdiction within the Municipality. In addition to these design criteria, and in any case where this document requires expansion or clarification, the latest revisions of all applicable and relevant codes and standards shall be used for reference by the Design Engineer. These documents include, but are not limited to, the latest editions of:

"Standard Specification for Municipal Services", prepared by the Nova Scotia Road Builders Association and the Nova Scotia Consulting Engineers Association.

"Standard Specifications", prepared by the Nova Scotia Department of Public Works.

"Atlantic Canada Standards and Guidelines Manual for the Collection, Treatment and Disposal of Sanitary Sewage", prepared by the Nova Scotia Department of the Environment and Climate Change.

"Atlantic Canada Guidelines for the Supply, Treatment, Storage, Distribution and Operation of Drinking Water Supply Systems", prepared by the Nova Scotia Department of the Environment and Climate Change.

Nova Scotia Department of Public Works (previously Nova Scotia Department of Transportation & Infrastructure Renewal) Specifications for Subdivision Roads in Urban and Rural Areas

Subdivision By-laws for the Municipality of the District of West Hants, Town of Windsor, Town of Hantsport (now West Hants Regional Municipality) and successor documents.

Transportation Association of Canada (TAC) Geometric Design Guide for Canadian Roads, Latest Edition

American Water Works Association Standards

"Water Supply for Public Fire Protection", prepared by the Fire Underwriters Survey- Insurers Advisory Organization (IAO)

National Fire Protection Association (NFPA) Hydraulic Institute Standards

Canadian Standards Association (CSA) National Building Code (NBC) of Canada

National Plumbing Code (NPC) of Canada National Fire Code (NFC) of Canada Canadian Electrical Code (CEC) Underwriters Laboratories of Canada (ULC)

National Electrical Manufacturing Association (NEMA)

All contract documents prepared for municipal services systems within the Municipality shall contain a clause requiring the Applicant and the Applicant's contractors and sub-contractors to carry out all work in compliance with all applicable Municipal, Provincial, and Federal Regulations, including, but not limited to, the Nova Scotia Occupational Health and Safety Act. 1996, c. 7, s. 1.

Any available recorded engineering drawings of municipal services systems will be provided to the Design Engineer for information only. Design Engineers are responsible for verifying the information in the field prior to any detailed design.

No municipal services or streets shall be constructed until the design has been submitted to the Development Officer and approved by the Municipal Engineer as part of the municipal approval process. The Municipal Engineer's decision shall be final and binding in matters of design and construction. No alternatives to the construction of the design are permitted unless approved in writing by both the Design Engineer and the Municipal Engineer.

All permits and approvals from the NSECC and NSDPW (where necessary) and other applicable regulatory authorities shall be obtained by the Applicant or their agent. Copies of the approved permits and approvals shall be submitted for consideration by the Municipal Engineer prior to Tentative Approval as part of the municipal approval process. Further information on submission requirements is included in Section 3.0 of this document.

Upon Tentative Approval, a meeting between the Municipality and the Applicant's contractor and Design Engineer (or other Professional Engineer who will be inspecting the construction) is required prior to commencing construction of all services being turned over to the Municipality. Construction documents must be submitted to the Development Officer in accordance with Section 3.0 below and must include all pertinent requirements stipulated in the Municipality's approval documents or required by other agencies.

Prior to receiving Final Approval, one (1) digital copy, one (1) reproducible copy of the original record drawing (reviewed and revised as per the Municipality's comments), and one (1) paper copy must be delivered to the Municipal Office.

The Municipality will periodically revise the design criteria, guidelines, and specifications contained in this document to conform with advances and improvements in engineering practices. The changes will be noted in a revision record and will be available to users of this document. It is the responsibility of the Design Engineer to remain current with revisions to this document.

2.0 DEFINITIONS

“Approval” means an approval of the Municipal Engineer. The decision of the Municipal Engineer will be final and binding in all matters of design and construction. However, the Municipal Engineer does not certify any installations, procedures, equipment, or materials nor do they approve or evaluate testing laboratories. Approvals will be based on compliance with these Specifications and/or other appropriate standards as indicated throughout this document. Tentative Approval and Final Approval requirements are as set out in the Municipality of the District of West Hants; Town of Windsor, and Town of Hantsport (now West Hants Regional Municipality) Subdivision By-Laws – for the applicable area until such time as a West Hants Regional Municipality Subdivision By-law is in place.

“Act” means the Municipal Government Act, 1998, c. 18, s. 1 and amendments thereto.

“Agreement” means a contract between the Subdivider and the Municipality which describes the responsibilities of each party with respect to the subdivision and servicing of land.

“Area of land” means any existing lot or parcel as described by its boundaries.

“Arterial road” means a road intended to move a relatively large volume of traffic at medium to high speeds, used where traffic movement is the primary consideration and land access secondary.

“Base course” means the crushed rock or aggregate which is placed immediately upon the sub-base course.

“Collector road” means a road intended to collect traffic from local streets and move it to the arterial, used where traffic movement and land access are of equal importance.

“Combined sewer” means a sewer that was designed to receive both wastewater and storm water. “Council” means Council of the West Hants Regional Municipality.

“Department of Environment and Climate Change” means the Nova Scotia Department of the Environment or its successors.

“Design Engineer or Designer or Engineer” means the Professional Engineer representing the Applicant, who has affixed their professional seal to the Engineering drawings, plans, and specifications for the proposed development and/or is the Professional Engineer who is responsible for ensuring the services are constructed to meet and satisfy the approved design. This person must be registered and/or licensed to practice engineering and must be in good standing in the Province of Nova Scotia.

“Developer or Applicant” means the owner of the area of land proposed and includes anyone acting on their behalf with their written consent.

“Development Officer” means that person appointed by Council pursuant to the Municipal Government Act who has the authority to administer the subdivision By-laws.

“Diameter” means the nominal internal diameter of the pipe unless noted otherwise.

“Director of Planning and Development” means the professional planner appointed by or acting on behalf of the West Hants Regional Municipality, to perform planning functions, and includes a person acting under the supervision and direction of the planner as defined herein.

“Drainage plan” means a detailed Management plan, including, but not limited to drawings and calculations of storm water runoff and the courses and channels of it, including floodplains, for one or more parts of an area of drainage for all lands tributary to, or carrying drainage from, land that is proposed to be subdivided.

“Feeder main” means a water main which typically receives flow from transmission mains or from pressure control facilities (i.e. booster pumping stations or pressure reducing valves) and which supplies water to several branch mains (distribution mains). The feeder main provides a significant carrying capacity or flow capability to a large area.

“Floodplain” means the low-lying area adjoining a watercourse that is subject to flooding, as defined in the Municipal Government Act and includes:

- “Floodway” means the inner portion of a flood risk area where the risk of flooding is greatest, on average once in twenty years and where flood depths and velocities are greatest.
- “Floodway Fringe” means the outer portion of a flood risk area, between the floodway and the outer boundary of the flood risk area, where the risk of flooding is lower, on average once in one hundred years, and floodwaters are shallower and slower flowing.

“Frontage” means the lot frontage measured as required by the Land Use By-law in effect for the area of land proposed to be subdivided.

“Inspection” means a field inspection by the Applicant’s or Owner’s Engineer at various stages of construction.

“Island” means an area of land completely surrounded by water at low tide.

“Land Registry Office” means the office of the Registrar of Deeds for the West Hants Regional Municipality.

“Local Road” means a road which has the main function of providing land access.

“Lot” means any parcel created by the filing of a plan of subdivision or an existing parcel.

“Manual” means the Municipal Service Systems Specifications Manual for the West Hants Regional Municipality.

“Municipality” means the West Hants Regional Municipality.

“Municipal Engineer” means the Director of Public Works as that person appointed pursuant to the Municipal Government Act who has the power and duty to administer provisions of the Act. The Municipal Engineer or designate reports to the Chief Administrative Officer for the Municipality acting on behalf of the West Hants Regional Municipality, to perform engineering functions, and includes a person acting under the supervision and direction of the engineer as defined herein.

“Municipal services systems” include sanitary sewer collection and treatment systems, water treatment and distribution systems, storm sewers, stormwater management areas, sidewalks, walkways, and roads which are, or are to be, owned, operated, and maintained by the Municipality.

“Private road” means any road which is not public shown on a plan of subdivision which extends to and has access to a public street. Where not totally located within the area of land being subdivided, the private road shall have an easement for right-of-way and access which is assignable and perpetual and which has been granted clearly by deed, will, Crown grant or other registerable instrument, registered in the Land Registry Office for this Municipality.

“Professional Engineer” means a Professional Engineer who is a member in good standing of Engineers Nova Scotia.

“Province” means Her Majesty the Queen in right of the Province of Nova Scotia.

“Provincial Regulation” means the requirements and provisions of the Province of Nova Scotia contained in any Provincial Statute or in any Regulation or Order made pursuant to the authority of any Statute of Nova Scotia.

“Public sewer system” means any sewer system which is owned by the Municipality.

“Public street” includes any street or road owned and maintained by the Municipality or the province; and

- “Municipal public street” means any street or road owned and maintained by the Municipality, including road structure and all slopes, ditches, channels, waterways, and appertaining structures necessary for proper drainage and protection as well as water and wastewater infrastructure (where available); and
- “Provincial public street” means any street or road owned and maintained by the Nova Scotia Department of Public Works excluding designated controlled access highways pursuant to Section 20 of the Public Highways Act R.S., c. 371, s. 1.

“Public water system” means any water system which is owned by the Municipality.

“Public Water Utility or Water Utility” means a water utility controlled by West Hants Regional Municipality. “Public Works” means the Public Works Department of West Hants Regional Municipality.

“Right-of-way easement” means an easement for right-of-way and access unrestricted in use extending to and having access to a public street. Where not totally located within the area of land proposed to be subdivided, the right-of-way easement shall be assignable and perpetual and clearly granted by deed or easement registered in the Registry of Deeds for the Municipality or declared to exist for the benefit of the land proposed to be subdivided by order of a court of competent jurisdiction. In either case the easement shall:

- if created or declared to have been created prior to August 6, 1984, have a minimum width of 3.0m (10ft),
or
- if created or declared to have been created on or after August 6, 1984, have a minimum width of 6.1m (20ft).

“Roadbed” means the portion of the roadway extending from shoulder line to shoulder line.

“Roadway” means the portion of road included between the outside lines of gutters, or side ditches including all the appertaining structures, and all slopes, ditches channels, waterways, etc. necessary for proper drainage and protection.

“Sanitary sewer” means a sewer system receiving and carrying liquid and water-carried wastes and to which storm, surface or ground waters are not intentionally admitted.

“Sanitary sewage” means wastewater from residential, industrial, institutional, and commercial buildings but excluding storm water or surface run-off and groundwater. It does not include contaminated liquid wastes or sewage at concentrations greater than those commonly found in domestic sewage.

“Sanitary sewage collection system” means the system consisting of all pipes, mains, equipment, buildings, and structures for collecting and pumping of sanitary sewage (including trunk sewers and pumping stations) operated by West Hants Regional Municipality. It is designed to collect and convey sanitary sewage from its point of origin to a disposal or treatment location.

“Service easement” means an allotment of land required to maintain and repair municipal services. In the event that sewer and/or water services are installed outside of public rights- of-way (ROW), the Applicant shall provide a service easement in favor of the Municipality. The service easement shall be constructed to provide access by maintenance vehicles including service trucks and heavy equipment.

“Sewer lateral or service lateral” means the Building Service Connection as defined by the Municipality. Sanitary sewer lateral means the pipe which conveys sanitary sewage from the property line to the main sanitary sewer. Storm sewer lateral means the pipe which conveys stormwater from the property line to the main storm sewer.

“Sewer” means system to convey sanitary sewage, groundwater, storm water or surface run-off and includes all sewer drains, storm sewer, storm drains, and combined sewers.

“Storm water” means water from precipitation of all kinds and includes water from the melting of snow and ice, groundwater, and surface water.

“Storm water system” means a method or means of carrying storm water, including ditches, swales, sewers, drains, canals, ravines, gullies, stormwater management ponds, streams, watercourses, floodplains, springs, creeks, streets or private roads, roadways, or driveways.

“Storm sewer or storm sewer system” means the system consisting of all pipes, mains, ditches, equipment, and structures for collecting and conveying storm water and surface runoff water, excluding sewage, operated by the Municipality. It is designed to collect and convey storm runoff from its point of origin to its point of discharge into a natural drainage system. The system includes the collection of storm water from foundation drainage systems.

“Street” means the entire width between the boundary lines of a street, road, or highway. “Street line” means the limit of the public road right of way (ROW).

“Sub-base course” means the crushed rock aggregate which is placed immediately upon the Subgrade.

“Subdivider” means the owner of the area of land proposed to be subdivided or consolidated and includes anyone acting with the owner’s written consent.

“Subdivision” means the division of any area of land into two or more parcels and includes a re-subdivision and a consolidation of two or more parcels.

“Subgrade” means the undisturbed portion of the roadbed upon which the sub-base course is to be placed.

“Surveyor” means a registered member in good standing of the Association of Nova Scotia Land Surveyors.

“Watercourse” means a lake, river, stream, ocean, or other body of water, per the Municipal Government Act.

“Water system or distribution system” means the system consisting of water mains, water service laterals from the water mains to street property lines and appurtenances carrying and distributing potable water for domestic and/or fire protection purposes and includes any pumping stations, pressure control facilities and reservoirs, treatment facilities, vested in or under the control of, the Municipality.

“Water service lateral” means the pipe that conveys water from a water main to the building requiring service.

“Wearing surface” means the exposed material placed directly upon the base course which comprises the traveling surfaces.

3.0 SUBMISSION REQUIREMENTS

This section is intended to assist the Design Engineer, acting on behalf of the Applicant for subdivision approval, prepare a submission for the approval of municipal services. This section must be read in conjunction with the Subdivision By-law applicable to the area under consideration.

There are three stages of approval: Concept Plan Approval, Tentative Plan Approval, and Final Plan Approval. Subdivisions may be approved without a Concept Plan and/or a Tentative Plan at the discretion of the Development Officer.

3.1 CONCEPT PLAN APPROVAL

Where land is to be subdivided in phases or new public streets or private roads are proposed, the Applicant must submit one (1) paper copy and one (1) digital copy of a concept plan to the Development Officer for approval. The purpose of the concept plan is to provide a preliminary layout, for a full review, of the proposed development before any advanced design work is done. To save time and expense, it is suggested the applicant contact the Development Officer to discuss the proposal prior to submitting a concept plan.

A concept plan does not have to be surveyed; however, it must be drawn to scale. It must show contours at 5m intervals, the estimated number of lots, the proposed street layout with connections to existing streets, and the proposed location of future parkland. The concept plan must be approved before the Development Officer can approve a tentative or final plan of subdivision.

A Concept Plan must include at the minimum:

- Approximate property boundary of parcel or parcels to be subdivided;
- Owner of the property to be subdivided;
- Natural features such as watercourses, wetlands, and contours;
- Existing public roads and services near the property;
- The proposed streets;
- Current zoning;
- Estimated number of lots/units;
- Proposed parkland; and
- A statement of how the lots will be serviced (i.e. municipal sewer/water or well and septic).

3.2 TENTATIVE PLAN APPROVAL

Once a concept plan has been approved, the Applicant shall apply for a tentative plan approval before proceeding with construction of services. The following material shall be submitted for tentative approval:

3.2.1 Survey Plan and Application

Application for plan approval, one (1) paper copy, and one digital (1) copy of a Tentative Plan of Subdivision.

3.2.2 General Service Plan

One (1) paper and an electronic copy of a plan showing the width and location of proposed streets and/or private roads and their intersection with existing public streets, tributary service areas, and proposed services, including pipe sizes, valves, hydrants, manholes, lift stations, directions of flow, and points of connection to existing systems.

3.2.3 N.S. Department of Environment and Climate Change Permit to Construct

A copy of the permit to construct from NSECC for services under their jurisdiction required prior to tentative approval.

3.2.4 Other Permits

Other permits, such as Work within Right-of-Way from NSDPW and Watercourse Approvals from NSECC may be required and it is the responsibility of the Developer to obtain these permits.

An application for tentative approval of municipal services shall provide the following material conform to the specified requirements, in addition to the minimum requirements of the Subdivision By-law:

3.2.4.1 Sanitary Sewer Systems

a) General

Plan indicating tributary service areas, existing sanitary sewer system, and proposed sanitary sewer system. The proposed sewer system shall include manhole locations, size of mains, flow direction, and connection point(s) to the existing system. The plan shall also include calculations showing tributary area to each pipe, peak flow to each pipe, and capacity of each pipe. Calculations to be as per Section 6.0.

Technical Specifications are required, and contract documents are required if applicable.

b) Gravity Systems

- Plan and profile drawings. Scale to be at least 1:500 Horizontal, 1:50 Vertical;
- Cross sections and detail drawings; and
- Design summary in tabular form with the following design information:
 - Population density
 - Peak flow
 - Design flow
 - Pipe size
 - Slope
 - Minimum and maximum flow velocity
 - Depth of flow

c) Pump Station and Force Main

Detail drawing for each lift station giving pump data, invert elevations for gravity inlet, overflow, and force main, float elevations, base elevation, top elevation, wet well size, bypass piping arrangement, and other relevant details, such as system and pump curves.

Design information in tabular form with the following design information:

- Minimum, average, and peak flow rates;
- Pipe size and velocity in force main; and
- Pump cycle time.

3.2.4.2 Water Systems

Plan indicating existing and proposed water system, including pipe diameter and material, valve location, hydrant location, location of bends, tees, wyes, and connections to the existing system.

Technical Specifications are required, and contract documents are required if applicable. Plan and profile drawings. Scale to be at least 1:500 Horizontal, 1:50 Vertical.

Design information in tabular form with the following design information:

- Population density;
- Domestic demand;
- Fire flow requirements;
- Maximum and minimum static pressures under normal operating conditions;
- Residual pressures under fire flow conditions; and
- Easements or right of way necessary to carry out the proposed work.

3.2.4.3 Storm Drainage Systems

Plan indicating the contributing area, the area tributary to each inlet, and the existing and proposed storm drainage system. A report showing the calculation of flows and required storage for retention and detention ponds.

Design information in tabular form with the following design information:

- Runoff rates tributary to each inlet from minor and major rainfall event;
- Design flow from minor and major rainfall events;
- Pipe, culvert, or channel size;
- Minimum and maximum flow velocity from minor and major rainfall events;
- Depth of flow in channels from minor and major rainfall events; and
- Easement or rights-of-way necessary to carry out the proposed work.

Assessments of impact on services from upstream development and downstream storm water capacity.

Technical Specifications are required, and contract documents are required if applicable. Plan and profile drawings to be at 1:500 Horizontal, 1:50 Vertical. Cross sections and detail drawings as well as a subdivision grading plan for the full development are required.

Subdivision grading plans including:

- Contours;
- Minimum basement floor or slab elevation;

- Elevations at exterior of house corners;
- Elevations at corners of each proposed lot;
- Arrows on each lot showing surface runoff flow direction;
- Drainage features on or near each lot such as ditches, catch basins, swales, and/or watercourses; and
- 1:100-year flood elevation on any watercourses near, on, or adjacent to any proposed lot.

Sample Subdivision Lot Grading Plan:

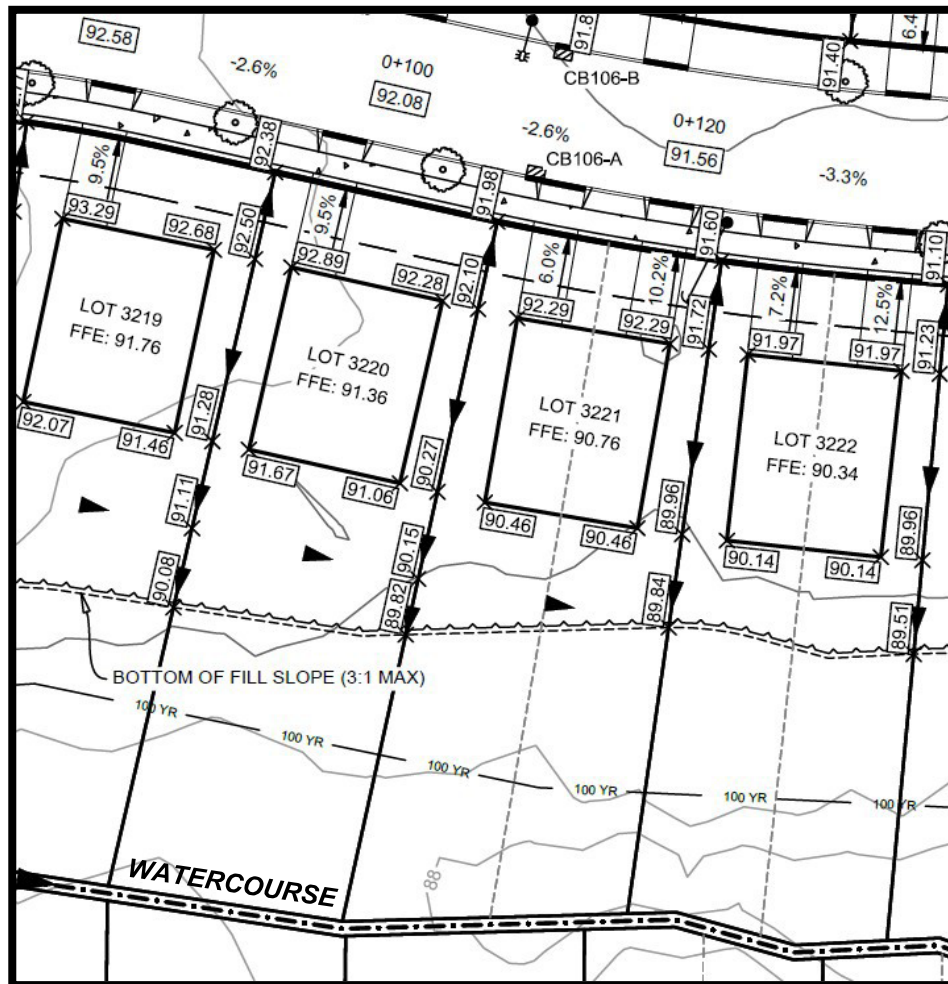

Details of erosion and sedimentation control measures, and other relevant details as required or as requested by the Municipal Engineer.

3.2.4.4 Municipal Streets

Plan and profile drawings indicating the following:

- Existing and proposed profiles of road centerline;

- Proposed grades (%);
- Horizontal and vertical curve data sufficient to ensure compliance with these specifications;
- Detail showing proposed road cross section elements complete with all elements of the roads including right-of-way width to accommodate cut and fill operations;
- Spot elevations of any watercourse, prominent rock formation, areas subject to flooding and other natural features within or immediately adjacent to the proposed street right-of-way; and
- Sizes of roadway and driveway culverts (see Section 5.5.4.3).

3.3 FINAL PLAN APPROVAL SUBMISSION REQUIREMENTS

This section specifies the submission to be made for review at the final approval stage. All services are to be approved by the Municipal Engineer. The Development Officer shall not approve a Final Plan of Subdivision with proposed sanitary sewer, water, and storm drainage system(s) and municipal street(s) until the services have been approved by the Municipal Engineer.

For final plan approval, all requirements for tentative plan approval must be met, along with the additional requirements listed below:

3.3.1 Close Out Report

3.3.1.1 General

All requirements for final plan approval shall be presented in a single bound copy and a digital copy of the "Close Out Report" (.pdf). Any copies of plans required for tentative and final approval shall have one (1) additional copy in the Close Out Report. The hard copy Close Out Report is to be provided in a binder.

The Close Out Report shall be complete in all respects prior to the Municipality granting final approval and shall follow the specific sequence set out in the requirements listed in Clause 3.3.1.2.

The Developer shall complete all revisions of the Close Out Report to meet the requirements of the Municipality.

3.3.1.2 Survey Plan and Application (Section A of the Close Out Report)

- Application for plan approval, one (1) paper copy, and one (1) electronic copy of a Final Plan of Subdivision; and
- Required processing fees.

3.3.1.3 Certification of Compliance (Section B of the Close Out Report)

- A certificate of compliance is required from a Professional Engineer stating that the streets and services have been constructed in accordance with the approved drawings and requirements of the Subdivision By-law and the Municipal Services Specification

Manual, including a Professional Engineer's certification of inspection and certification of compliance as per the NSECC permit to construct.

3.3.1.4 Maintenance Bond (Section C of the Close Out Report)

- Statement of construction costs;
- Statutory declaration indicating that all labour and materials used in the construction of the subdivision have been paid in full (see Appendix A – Sample Statutory Declaration); and
- Maintenance deposit in the amount of 10% of the cost of municipal infrastructure, to be held for a period of one (1) year from the date of final approval. The Municipality may, at their discretion, extend the term beyond one year.

3.3.1.5 Plan of Streets, ROW's, and Easements (Section D of the Close Out Report)

- One (1) paper copy and one (1) electronic copy of Final Plan of Subdivision showing the municipal public streets and all drainage rights-of-way outlined in red, road reserves outlined in yellow, and easements outlined in green.

3.3.1.6 Deeds and Easement Documentation (Section E of the Close Out Report)

- Warranty deeds for all property to be transferred to the Municipality, including property descriptions and plans;
- Easement documentation including property description and plan;
- Title certificate by Developer's solicitor for land and easements being transferred; and
- Document registration fees.

3.3.1.7 Operation and Maintenance Manuals (Section F of the Close Out Report)

Operation and maintenance manuals are required for pumps and other similar equipment. The contractor is to provide this information for both private development projects and municipal projects unless agreed to otherwise with the Municipality. See Section 6.2.2 for details.

3.3.1.8 Inspection and Testing Reports (Section G of the Close Out Report)

The following inspection and testing results, as applicable, must be provided. Municipal Staff are to be on site for all tests and inspections with the option to choose test locations. The contractor is to provide this information for both private development projects and municipal projects unless agreed to otherwise with the Municipality.

a) Water, Sanitary, and Storm Systems

- Video inspection and report for sanitary sewers in a format approved, in advance, by the Municipal Engineer;
- Vacuum test report for all manholes, certified by CET or P. Eng.;
- Pump station start-up report. Startup to be carried out in the presence of the Municipal Engineer or their designate. Draw down test confirming pump system capacity to be included;
- Air test results for all sanitary sewers, certified by CET or P. Eng.;

- Hydrostatic leakage test results for water system, stamped by a CET or P. Eng.;
- Bacterial test results (presence / absence) for water lines provided by accredited lab;
- Chlorination / dechlorination test results;
- Compaction test results on pipe bedding and trench backfill; and
- Engineer approved shop drawings.

b) Road Systems

Before the constructed roads are approved and accepted, the Municipality must receive confirmation from NSDPW that all their requirements have been met in addition to municipal requirements. In addition, a certification shall be required from a Professional Engineer confirming the roads and drainage systems within the subdivision have been constructed in accordance with the approved specifications and plans. Submissions must include:

- Particle size analyses, fractured faces, absorption, LA abrasion, plasticity index, and micro-deval for base and sub-base gravels;
- Compaction test results on subgrade, sub-base, and base courses at a minimum of every 150m for each lift of material placed;
- Test results for asphaltic concrete paving, mix design, and compaction results;
- Test results for curb and gutter construction including tests on subgrade, subbase, and base course; and
- Concrete test results for concrete curb and concrete sidewalks.

3.3.1.9 Record Drawings (Section H of the Close Out Report)

Electronic record drawings in an AutoCAD (*.dwg) file format and a GIS Shape File format (*.shp or *.gdb) and coordinate data (for all constructed infrastructure) in spreadsheet form (*.xls or *.csv) and reproducible record drawings stamped by a Professional Engineer with one (1) paper copy and one (1) digital copy (.pdf).

When the preceding specifications have been satisfactorily adhered to, as determined by the Municipal Engineer, the Municipal Engineer then will recommend to the Development Officer that the proposed municipal street(s) be approved. The Development Officer will not approve a Final Plan of Subdivision with proposed municipal street(s) until the street(s) have been approved by the Municipal Engineer. It is the approval of the Final Plan of Subdivision that officially lists the street(s) in the subdivision.

3.3.2 Alternative to Complete Construction and Acceptance Prior to Final Approval

Where a Developer wishes to obtain approval prior to completing construction of the street and services, the following is required:

3.3.2.1 Street Completion Agreement

A street completion agreement satisfactory to the Municipality shall be signed, sealed, and delivered for final approval. See Appendix B – Sample Street and Servicing Agreement for a template of this agreement.

3.3.2.2 Performance Surety

A Performance Bond, certified cheque, or irrevocable letter of credit in the form and with the content satisfactory to the Municipality, in the amount of 150% of the estimated cost of completing the streets and services, to be held for a minimum period of one (1) year from the date of final approval of the subdivision as granted by the Development Officer. Should the Developer not meet all requirements of the Municipality's Terms of Final Approval within the performance period, the Municipality will have the right to use the surety to complete the work by a third party. See Appendix C – Sample Letter of Credit for a template of the irrevocable letter of credit. Within thirty (30) days following the completion of the streets and services, the Developer shall provide all the items required under Section 3.4. The Municipality may, at their discretion, extend the term beyond one year.

4.0 MUNICIPAL STREET DESIGN

4.1 SCOPE

This section specifies the requirements for design of all Municipal public streets within the Municipality shall meet all the specifications within this section.

A municipal Public Street consists of the road structure and all slopes, ditches, channels, waterways, and appertaining structures necessary for proper drainage and protection as well as water and wastewater infrastructure (where available).

4.2 GEOMETRIC DESIGN SPECIFICATIONS

Design: The Function of locating roads and building lots relative to topographical features constitutes the practice of engineering as defined by the Engineering Profession Act of Nova Scotia. Therefore, the design of subdivisions and their services when submitted to the Municipality must be over the Seal of a Professional Engineer.

4.2.1 General

4.2.1.1 Design Standards

These specifications cover the more common aspects of design encountered in subdivision development. In cases where these specifications need to be expanded or additional specifications are required, the "Geometric Design Standards for Canadian Roads and Streets" as published by Transportation Association of Canada (TAC) shall be used as a guide. In general, a design speed of 60 kilometres/hour will be used for all subdivision roads unless a higher design speed is required by the Municipality. A design speed of 30km/hr is acceptable for cul de sac, P-loops, or crescents with a length of 400m or less.

Street designs should recognize and/or incorporate natural features such as watercourses, wet areas, habitats, and rock outcrops.

See Appendix E – Standard Details for Typical Road Cross Sections (local urban, rural, and private).

All street names, street signs, and posts shall be approved by the Municipality. Street signs and posts shall be installed by the developer in accordance with the Civic Addressing By-Law, and using the material, size, and color stipulated by the Municipality. Locations to be approved by the Municipality.

4.2.2 Right-of-Way

4.2.2.1 Minimum Widths

The minimum right-of-way width will normally be 20m. In most cases this right of way will be sufficient. However, in certain instances, the Municipality may require a greater right-of-way width to facilitate traffic, construction, and/or maintenance requirements.

A 16m right-of-way may be accepted by the Municipality where the municipal street is fully serviced with curb, gutter, asphalt, water, sanitary sewer, and stormwater systems.

4.2.2.2 Cut and Fill Slopes

Any property susceptible to damage because of construction must be within the right-of-way. All slopes (either in cuts or fills), required for road and infrastructure construction, must be included within the right-of-way.

All back slopes steeper than 3:1 sloping to the bottom of the ditch shall be included in the right of way. A minimum 3 m bench shall be provided on cut slopes that would not otherwise end at the edge of the right of way.

Side slopes in cuts shall be no steeper than 2:1 (horizontal to vertical) and 1:4 in rock cuts (where confirmed by a geotechnical engineer) or as otherwise required. All embankment slopes will be 2:1 or flatter at the discretion of a geotechnical engineer.

Retaining walls are not permitted within the road right of way unless approved by the Municipality.

4.2.2.3 Acceptable Access for Adjacent Properties / Road Reserves

Acceptable road reserves to adjacent properties must be identified and deeded to the Municipality. These reserves must be not more than 400 m apart. Road reserves and their spacing are subject to acceptance by the Municipal Engineer. The road reserves will be located along the subdivision boundary in such a manner as to not prejudice development of the adjacent land.

Road reserves must be constructed to the property boundary with the base course and municipal services installed. A guard rail barricade with WA-8 warning sign shall be installed across the roadbed at the beginning of the road reserve.

The Developer shall be responsible for connecting to and upgrading existing road reserves to the final design regardless of the level of construction.

4.2.3 Road Layout

4.2.3.1 General

Where practical, proposed roads shall be laid out as extensions to existing roads, either in the same subdivision or in adjacent subdivisions. Where temporary cul-de-sacs or turning areas exist in previous developments, the Developer shall be responsible for removing the temporary works and reinstating the road to its final design.

In cases where the proposed road ends within a property and there are plans to extend the road at a future date, the Municipal Engineer may accept a temporary turning area in lieu of a temporary cul-de-sac. Temporary cul-de-sacs and turning areas shall be constructed to the same standard as the road. In un-serviced areas, the turning area shall be surfaced with gravel. In serviced areas, the normal curb along the front of the turning area shall be deleted and the turning area shall be surfaced with asphalt.

The minimum length of road eligible for takeover is 150 m (not including permanent cul-de-sacs); shorter road lengths may be considered for takeover at the discretion of the Municipal Engineer.

4.2.3.2 Cul-de-Sacs

All cul-de-sacs must end in a permanent or temporary turn around area as approved by the Municipality. Cul-de-sacs are not permitted where the land can be effectively serviced by other road layouts.

The grade of the bulb of a permanent cul-de-sac shall not exceed 4%. The maximum length of a cul-de-sac shall be as established in the Subdivision By-Law but shall not exceed 400m unless otherwise approved by the Municipal Engineer.

In areas lacking any existing or planned streets with which to connect, the cul-de-sac shall include prolongations (see Appendix E – Standard Details), extending to adjoining parcels in locations where future street connections appear to be feasible. Where no future vehicular traffic connection is feasible, wherever possible, the end of cul-de-sacs shall include a 6m access to abutting properties to provide potential access for emergency vehicles, municipal sewer, and water services, as well as pedestrian traffic.

4.2.3.3 Grassed Boulevards

Grassed boulevards are to be provided between the sidewalk and curb. See standard details.

4.2.3.4 Guard Rail

Guard Rails are required on fills of 3m or greater (unless a slope of 6:1 can be provided) and in other hazardous areas.

4.2.4 Intersections

4.2.4.1 Intersections with Provincial Highways

Where any new roads meet existing Provincial highways, the minimum distance between these intersections shall be in accordance with Provincial requirements. The Province shall review and approve connections with Provincial roads or highways.

4.2.4.2 Intersections with Local Roads

The minimum distance between intersections of local roads will be 75m measured centre line to centre line.

All intersecting roads must intersect at an angle of 70 to 90 degrees for a minimum distance of 30m from the intersection measured from the respective centre lines.

4.2.4.3 Offset Intersections

Minimum distance between offset intersections shall be 50m.

4.2.5 Vertical Alignment

4.2.5.1 Grades

Straight or gently rolling grades with proper vertical curves are required to provide adequate stopping sight distance. In all cases a profile will be required, showing existing and proposed grades. In general, a grade of 8 percent will be considered the maximum allowable, however, grades more than 8 percent may be approved in exceptional circumstances and with prior approval by the Municipality. The minimum grade shall be 0.5 percent. Grades at intersections shall not exceed 4 percent for at least 15m measured from the shoulder or face of curb of the intersecting road.

Ditch grades less than 1 % require approval of the Municipal Engineer. Ditch grades more than 4 % require erosion protection acceptable to the Municipal Engineer. Minimum curb grade shall be 0.5%.

4.2.5.2 Vertical Curves

The vertical curve length for both sag and crest curves shall not be less than the minimum values specified below:

| Minimum K Factors to Provide Stopping Sight Distances on Vertical Curves | | | |
|--|--------------------------------|--------------------------------|-----------------|
| Road Classification | Crest Vertical Curves | Sag Vertical Curves | |
| | Rate of Vertical Curvature (K) | Rate of Vertical Curvature (K) | |
| | | Headlight Control | Comfort Control |
| Cul-de-sac, Crescent, or P Loop less than 400 m | 4 | 7 | 4 |
| Local Road | 13 | 18 | 9 |

Streets without streetlights shall be designed using headlight control. For other road classifications (such as collector roads), refer to TAC.

4.2.6 Horizontal Alignment

Horizontal curves shall have a minimum horizontal curve radius of 90m. The horizontal alignment centreline shall be a straight line for a minimum of 10 m measured from and along the intersection of the centreline of the approach street and the edge of the shoulder / curb of the street to which it is connecting.

For local cul-de-sacs and P-loops or crescents with a length less than 400m a minimum radius of 30m may be used.

4.3 WALKWAYS AND SIDEWALKS

4.3.1 Walkways

Selection of locations for walkways shall consider the requirements for pedestrian circulation for the neighbourhood. Where possible, walkways shall be designed to suit the natural topography.

Walkways shall have a minimum right of way width of 6m (20ft.). At the discretion of the Municipality, additional easement or right of way width may be required to facilitate construction and maintenance of municipal infrastructure (i.e. to accommodate wastewater and stormwater mains).

The walkway travelled portion shall be centered within the right of way unless approved by the Municipal Engineer and shall have a minimum width of 1.8m (6ft.). See standard detail.

Walkways shall be located and designed whenever possible so that the grade of the walkway shall not exceed 8%. Steeper grades may be permitted only where the topography makes it impractical for grades to be less than 8%, or to avoid the installation of stairs.

Pedestrian ramps shall be constructed at the ends of walkways where curb and gutter are present. Pedestrian ramps shall be placed at all street crossing locations.

The right of way shall be graded to control surface water and major drainage within the right of way. Landscaped and sodded swales, catch basins, pipe, and drains shall be provided to control erosion and maintain a safe surface. Swales, where required, shall not be located closer than 600 mm from the edge of the travelled portion.

Walkways shall be lighted and shall be oriented as to benefit from street lighting where possible. Lighting for walkways shall be shielded and directed downward to ensure there is no light spilling, glare, or light cast over neighbouring properties. The maximum distance between lights on a walkway shall be 75m.

4.3.2 Sidewalks

Concrete sidewalks (one side) are required on any new local road in the communities of Windsor and Hantsport, within Growth Centres, and as otherwise required by policy in a Municipal Planning Strategy.

The minimum width of the sidewalk shall be 1.8m (6ft.). All sidewalks and driveway ramps adjacent to sidewalks shall be designed and constructed using concrete.

Pedestrian ramps shall be installed at all intersections where a sidewalk exists, and at walkway and trail locations. All pedestrian ramps shall have Tactile Walking Surface Indicators (TWSI) as recommended by the Design Engineer and accepted by the Municipal Engineer.

Outside edges and expansion joints shall have tooled edges.

The minimum grade across a sidewalk shall be 2%, but not more than 3%, unless otherwise approved by the Municipal Engineer.

Construction joints of mastic fibrous material extending through the entire thickness of the concrete slab shall be placed as follows:

- Where concrete is to be placed against existing concrete;
- Where the sidewalk abuts the curb;
- Around all structures abutting the sidewalks including utility poles, catch basins, etc.; and
- At maximum 18m (59ft.) intervals of sidewalk continuous placement.

In locations with sidewalks, curbs, and pedestrian ramps, Tactile Walking Surface Indicators (TWSI) shall be installed on both sides of each road at all roadway intersections with sidewalk or a walkway.

4.4 ROAD CONSTRUCTION

4.4.1 Construction Season

The normal completion date for streets and related works constructed within a subdivision is to be November 30 of each year in order to allow for inspection and approval by the Municipality.

4.4.2 Municipal Inspections

The Municipality must be notified in advance before construction work begins on any subdivision road. Inspections by the Municipality shall not relieve the Design Engineer of responsibility for inspection of the work. Witness inspections by the Municipality are required at the following stages before construction proceeds to the next stage:

- After clearing;
- After grubbing;
- After completion of subgrade (roll test);
- After completion of base course;
- After completion of surface course; and
- Upon project completion.

4.4.3 Construction Requirements

The subgrade must be well drained and compaction tests shall be taken by a third-party testing firm, approved by the Municipality. Any unsuitable material including soft or yielding material shall be removed, replaced with suitable material, and compacted.

In addition to the specific requirements identified in this section, all Municipal streets must be constructed in accordance with the following:

- Roots, stumps, limbs, moss, sod, and other organic or deleterious material shall not be placed in roadway fills or allowed to remain under the roadway;
- The road surface top width and travel surface width shall be in accordance with Typical Road Cross Sections;
- The travel surface shall have a sub-base and a base course of crushed, screened gravel;

- The sub-base course shall conform to Gravel Type 2, Division 3, Section 2 of the Nova Scotia Department of Public Works Standard Specifications. The sub-base course must be applied to a compacted depth as noted in the Typical Road Cross Sections;
- The Base Course shall conform to Gravel Type 1, Division 3, Section 2, of the Nova Scotia Department of Public Works Standard Specifications. Base course shall be applied to a compacted depth as noted in the Typical Road Cross Sections;
- New streets constructed must be coated with an Asphalt Concrete in accordance with Nova Scotia Department of Public Works Standard Specifications Division 4, Section 4 for Asphalt Concrete; and
- The developer shall be responsible for the following:
 - Arranging for complete inspection and testing of the installation of a street at various stages as approved by the Municipality.
 - Giving reasonable notice to the Municipality of the proposed test date, site, and time.
 - Allowing the Municipality to inspect the installation at any stage or to verify or confirm any required test.

4.5 INSTALLATION OF A DRIVEWAY ENTRANCE ON A MUNICIPAL ROAD

The applicant is responsible for all aspects of construction, including but not limited to the supply of culvert pipe and backfill materials, rip rap, labour, and traffic control. Work may be done by the applicant, or a contractor engaged by the applicant, however, ultimate responsibility for installation rests with the applicant.

The applicant must notify the Public Works Department for the Municipality when work is to commence. Once the driveway is completely installed, the applicant must notify the Public Works Department (Municipality), to arrange for an inspection. If the Department is not satisfied with the installation, the applicant will be notified of the deficiencies and asked to correct them. A reinspection then will be required.

Driveways shall drain away from buildings toward the road. The minimum driveway grade shall be 2% and the maximum grade shall be 8%. Reverse grades or steeper grades are not permitted unless accepted otherwise by the Municipal Engineer.

In addition, the applicant shall:

- Save and hold harmless the Municipality against all claims for personal injury and/or property damage of whatsoever nature, both during and after the execution of work covered by this section, where, in the opinion of the Municipality, any such claim arises from the execution of the work;
- Bear the cost of all damage occurring during the laying of the pipe or other work undertaken to the road shoulders, curbs, ditches, culverts, pavements, and other installations and all subsequent damage costs to the road/street that are, in the opinion of the Municipality, attributable to the work under this section;
- Provide that on completion of the work, the road shoulder shall be left in a neat condition and dressed with gravel containing no stones larger than 20mm (3/4") in dimension; and
- Carry out the work in every respect satisfactory to the Municipality.

All driveway entrances outside the jurisdiction of WHRM shall be installed in accordance with Nova Scotia Department of Public Works.

5.0 STORM WATER DRAINAGE DESIGN

5.1 SCOPE

This section specifies the requirements for a storm drainage system. A storm drainage system is a system which receives, carries, and regulates flows in response to precipitation which include overland flow, sub-surface flow, groundwater flow, and snow melt.

The following design objectives are to be followed for the design of storm drainage systems in the Municipality:

- Prevent loss of life and protect structures and property from damage due to a major storm event;
- Provide for safe and convenient use of streets, lots, and other improvements during and following storm events;
- Preserve natural watercourses and minimize the long-term effect of development on receiving watercourses and groundwater; and
- Convey stormwater from upstream and on-site sources and mitigate the adverse effects of such flow on downstream properties.

In addition to the following specifications, all storm drainage systems shall meet the requirements of NSECC. No system shall be constructed until the design has been approved by both the Municipal Engineer and NSECC.

5.2 DESIGN APPROACH

5.2.1 Storm Drainage Systems

A Minor Drainage System consists of ditches, swales, driveway and roadway culverts, subsurface interceptor drains, curb & gutter, catch basins, pipes, ponds, manholes and laterals.

A Major Drainage System consists of ditches, curbs, roadways, roadway culverts, open channels, retention and detention ponds, floodplains, and natural water courses.

The developer must provide a lot grading design stamped by a Professional Engineer indicating overall drainage and identifying that a major storm condition will not affect building construction on the lot. Grade of the top of the building foundation shall be a minimum of 450mm above the centre line of the road (unless approved otherwise by the Municipality).

5.2.2 Downstream Drainage Systems

All downstream drainage systems must have adequate capacity to receive and carry discharge from the proposed storm drainage system in addition to existing tributary discharge. An investigation of the downstream system shall be carried out by the design engineer from the outfall location of the proposed storm drainage system to a point sufficiently downstream that will demonstrate no adverse impacts on downstream lands, such as erosion or flooding.

The effect on downstream development will be assessed by the Design Engineer based on this investigation. Mitigative measures may be required to alleviate any adverse downstream impacts.

5.2.3 Design Storm Frequencies

5.2.3.1 Minor Systems

Driveway culverts, storm sewers, and other minor drainage systems shall be designed based on a design storm frequency of 1 in 5 years, except in areas designated for commercial and industrial development in the Municipal Planning Strategy.

Areas designated for commercial and industrial development in the Municipal Planning Strategy shall be designed based on a design storm frequency of 1 in 10 years.

5.2.3.2 Major Systems

Roadways, road cross culverts, and other major drainage systems shall have a capacity to convey stormwater from a design storm frequency of 1 in 100 years.

For design purposes, the capacity of any watercourse crossings, shall be based on a design storm frequency of 1 in 100 years.

5.2.4 Foundation Drains

Foundation drains shall normally be connected by gravity to the piped stormwater system. Relative elevations of the storm main and foundation drains shall be such that foundation drains are above the hydraulic grade line of the major storm. Where the stormwater system discharges into a watercourse, ditch, or drainage corridor, foundation drains connected to the system shall be above the major storm flood elevation at the point of discharge. Discharging a foundation drain to a Municipal roadside ditch is not recommended. The Municipality shall be held harmless from any liability for any personal injury or property damage should a foundation drain be constructed to discharge into a ditch.

5.2.5 Roof Drains

Roof drains are not permitted to be connected to the stormwater system and must not discharge to a driveway or other impervious surface draining to the road.

5.2.6 Institutional, Commercial, and Industrial Connections

Commercial, institutional, and industrial developments shall employ flow control devices upstream of the stormwater system connection which will limit the peak flow to less than 40% of the uncontrolled fully developed flow.

5.2.7 Connections to Public Property

The Municipal Engineer may require an extension of an appropriately sized pipe from the stormwater system to an appropriate location on the boundary of existing or future public property, such as parkland.

5.3 METEOROLOGICAL DATA

Intensity Duration Frequency Curves and Time – Depth Tables are included in Appendix D – Rainfall Data and are to be used for storm drainage design calculations.

5.4 DESIGN METHODOLOGY

The designer shall indicate the design methodology used. Techniques generally accepted are listed below:

5.4.1 Rational Method

The Rational Method may be used for the calculation of peak runoff rates for drainage basins up to and including 40 hectares (100 acres) in area. It may be used for preliminary design of systems serving larger areas.

This method shall not be used for the design of storage facilities.

Where run-off from an area that includes a significant proportion of undeveloped land is to be determined, winter run-off conditions must be determined, and the worst case used in design. For winter conditions, rainfall data for winter conditions must be used.

5.4.2 SCS Methods

The methods described in the US Soil Conservation Service Technical Report 55, 1975 (SCS TR 55) may also be used.

5.4.3 Storage Facilities

Stormwater storage facilities shall be designed using the Storage-Indication method. The design storm and inflow hydrograph must be developed using accepted methods.

Stormwater facilities to include an emergency spillway capable of discharging the 1 in 100-year flow.

The overflow spillway shall discharge into a watercourse or major storm drainage system capable of receiving and carrying the 1 in 100-year discharge from the structure, in addition to its rate of discharge upstream to the spillway.

Information must be supplied regarding maintenance and safety issues of a stormwater storage facility complete with long term maintenance and replacement costs.

5.5 DESIGN REQUIREMENTS

5.5.1 Location

All storm drainage shall be carried by either an unconfined natural watercourse, excavated ditch, or piped storm drainage system. No storm drainage is to be carried on, through, or over private property within a subdivision without appropriate easements.

Where storm drainage flows are directed onto abutting land, other than through a natural watercourse, a right-of-way or easement in favor of the Municipality must be provided. The minimum width of an easement is 6m (20ft.).

Where a need is identified by the Design Engineer to accommodate future upstream development, and where no future road reserve is available, a drainage right-of-way or an easement in favor of the Municipality must be provided.

Natural watercourses shall not be carried in roadside ditches or piped roadside storm drainage systems.

5.5.2 Discharge to Adjacent Properties

All concentrated storm drainage shall be self-contained within the subdivision boundaries, except natural run-off from undeveloped areas.

All concentrated run-off from the developed limits of a subdivision must be directed to either a natural watercourse or storm drainage system owned by NSDPW or the Municipality.

Discharge of run-off to adjacent properties other than in a natural watercourse requires:

- Approval from NSECC;
- That the developer obtains written consent from the adjacent property owner(s). The written consent must be filed with the Municipality and filed in the Land Registration Office along with the appropriate easements; and
- Drainage easements, with a minimum width of 6m, shall be provided in favor of the Municipality.

5.5.3 Buried Storm Drainage Systems

5.5.3.1 General

Storm sewer pipes shall be designed to carry, without surcharging, the peak rate of storm flow. Design must be approved by NSECC and the Municipal Engineer and have a Permit to Construct issued by NSECC.

5.5.3.2 Velocities

The minimum design velocity for storm sewers shall be 0.6 metres per second. Consideration shall be given to initial minimum cleansing velocity for phased development. This requirement shall be waived for the end of pipe systems where the minimum pipe size is used.

The maximum design velocity for a storm sewer shall be 4.6 metres per second for pipes up to and including 750mm in diameter. The maximum design velocity for storm sewer pipes greater than 750mm in diameter shall be 6.1 metres per second.

5.5.3.3 Pipe Size

The minimum diameter for a storm sewer main shall be 300mm.

Pipe sizes shall not decrease in the downstream direction unless approved by the Municipal Engineer. The exception is if the main to which the inlet is connected is 600mm diameter or larger, and if pipe storage is permitted or if oversized inlet piping required to overcome the effects of inlet control.

5.5.3.4 Pipe Material

- Stormwater mains shall be green PVC DR35 pipe, reinforced CSA A257.2 concrete pipe, or green PVC PS320 profile pipe; and
- All stormwater mains and catch basin leads shall be installed with gaskets.

5.5.3.5 Depths

The minimum depth for a storm sewer main located within the road right of way is 1.5m. The minimum depth for storm laterals at the property line is 1.0m.

5.5.3.6 Manholes

Manholes shall be installed at any change in pipe size, material, grade, or horizontal alignment, and at all stormwater main intersections and end points. The spacing of manholes shall not exceed 120m.

Manholes shall be pre-cast concrete with an iron frame and cover. Frames are to be adjustable. Covers are to have 2 vent holes and be labelled "STORM". Off street manholes are to have bolt down frame and cover.

Manholes shall be CSA A257 concrete, and all joints and connections shall have gaskets. Connections to existing manholes shall be made by core drilling and with approved connectors and installed in accordance with the manufacturer's instructions. Connections other than core drilling are subject to approval by the Municipal Engineer.

The minimum internal diameter of a manhole shall be 1050mm (42").

5.5.3.7 Service Laterals

All laterals from the main to 1.5m past the property line shall be provided by the developer or owner and shall have a minimum grade of 2 percent. Laterals must be green DR35, minimum 100mm in diameter and installed between the potable water and sanitary sewer laterals.

Laterals for future development shall be brought to the property line, capped, and a marker stake 50 x 100mm placed. Depth to lateral should be indicated and be marked "STORM".

Where a buried storm drainage system exists, foundation drains will normally be connected to the main by laterals. The invert of the lateral at the property line must be at least 610mm above the top of the main at the point of connection.

Where a buried storm drainage system does not exist, Section 9.14 of the National Building Code of Canada, latest revision, shall apply.

Under no circumstance shall foundation drains direct stormwater to the street surface, sidewalk, or adjacent property.

5.5.3.8 Catch Basins

Catch basins shall be installed at the curb of the street and shall be adequately spaced to prevent ponding on the street and to prevent water from entering on or flowing in the travel lanes during storm events corresponding to the design of the minor system. In no case shall the spacing of the catch basins exceed 120m.

Catch basin leads shall be connected to a storm drainage manhole or a catch basin. No more than 2 catch basins shall be connected in series before connecting to a storm manhole.

- Catch basin leads shall be gasketed CSA A257.A concrete pipe or green PVC DR35 pipe and shall be a minimum of 200 mm in diameter;
- Catch basin leads not connected to a manhole may be connected to a stormwater main with a fabricated fitting provided that the main is larger than the lead. Connections to existing mains shall be made with approved connectors, installed in accordance with the manufacturer's instructions;
- Catch basin leads shall have a minimum cover of 1.2 m below finished grade;
- Catch basin leads shall have a minimum slope of 1%;
- Catch basin leads shall be included in the CCTV report;
- Catch basin leads shall be connected to a manhole such that the lead invert is no higher than the obvert of the outgoing main or 1 m above the invert of the outgoing main whichever is higher, unless approved otherwise by the Municipality;
- Catch basin leads shall not protrude into catch basins or manholes by more than 50 mm; and
- Catch basin leads shall incorporate a flexible joint within 450 mm of the outside face of a manhole or main.

5.5.3.9 Inlets

Vertical grates shall be installed at inlets.

5.5.3.10 Outfalls

The design of outfalls shall take into consideration such factors as public safety, erosion control, and appearance.

5.5.4 Ditches / Open Channel Drainage System

5.5.4.1 Ditches

Roadway ditches shall conform to the standard cross section for local roads and shall have adequate capacity for the 1 in 100-year storm.

5.5.4.2 Velocities

The maximum velocity during a 1 in 100-year storm event in ditches or open channels shall not exceed the values which will cause erosion for the specified surface treatment (such as rock lining or grass).

5.5.4.3 Culverts

All culvert sizes shall be indicated on design drawings. The minimum size for any culvert shall be 450mm. The minimum depth of bury for any culvert shall be 500mm.

Culverts on a watercourse shall be designed for the 1 in 100-year peak flow with a headwater depth not greater than the diameter of the pipe.

Driveway culverts (where applicable) shall be CSA A257.2 concrete, HDPE PS320 dual wall corrugated pipe, or PVC PS320 profile pipe or an approved equivalent. Driveway culverts shall be designed for the 1 in 5-year peak flow with a headwater depth not greater than the diameter

of the pipe (except in areas designated for commercial and industrial development in the Municipal Planning Strategy, where the 1 in 10-year flow is to be used).

All road cross culverts shall be reinforced concrete pipe to CSA A257.2 unless alternate types are approved by the Municipal Engineer. Road cross culverts shall be designed for the 1 in 10-year peak flow with a headwater depth not greater than the diameter of the pipe.

5.5.5 Headwalls & Grates

All culverts and stormwater systems require headwalls for inlets and outlets. Culverts longer than 30 m and all stormwater systems require inlet grates with vertical bars; outlet grates are not permitted. The following standards shall be met:

- Headwalls shall be precast concrete;
- Grates shall be hot-dip galvanized steel;
- Headwalls over 1050 mm high require hot-dip galvanized handrails;
- Type 304 stainless steel anchors shall be used to fasten grates and handrails to headwalls;
- Bedding material for inlet and outlet structures shall be minimum 150 mm Type 1 gravel or as recommended in the geotechnical report;
- All steel components shall be completely fabricated prior to hot dip galvanizing;
- Streambed protection shall be installed upstream of the inlet structure and downstream of the outlet structure as per NSECC requirements; and
- Bell ends of inlet pipes shall be grouted flush with the headwall to provide a smooth transition to the pipe; outlet pipes shall be similarly grouted. Non-ferrous, non-shrink grout shall be used.

5.5.6 Detention Structures

5.5.6.1 Design Volume

Stormwater management ponds are to be sized to provide adequate storage volume necessary to limit post-development peak discharge rates to pre-development peak discharge rates for the 2-, 5-, 10-, and 100-year design storm events.

An additional volume allowance must be made so that a 300 mm freeboard is available for the 100-year design storm event.

5.5.6.2 Inlet & Outlet

Energy dissipation measures should be employed to reduce velocities through the pond and reduce the likelihood of re-suspending settled solids.

5.5.6.3 Flow Control Structures

Flow control structures typically include large diameter manholes with a concrete bulkhead separating the inlet and outlet sides of the structure. A series of orifices and weirs are arranged in the bulkhead to restrict peak discharge rates to pre-development levels.

An access manhole frame and cover shall be provided on both the inlet and the outlet sides of the flow control structure to facilitate inspection and maintenance.

5.5.6.4 Low Flow Channel

Stormwater management ponds shall provide a low flow channel from the inlet structure to the flow control structure, or the outlet structure. Low flow channels may consist of a concrete channel, half-pipe, rock lined channel, or perforated pipe within a granular drain.

5.5.6.5 Emergency Overflow

Stormwater management ponds shall have an emergency overflow to manage excess flows that may exceed the 1:100 design storm event or manage overflows if the outlet structure fails or becomes blocked.

The emergency overflow elevation should be set at 300 mm above the 1:100 flood elevation in order to meet minimum freeboard requirements and shall be integrated into the major drain system to limit property damage from an overflow event.

5.5.6.6 Maximum Side Slopes

Stormwater management ponds shall be constructed with maximum internal side slope of 4:1 (H: V). Side slopes of 5:1 (H: V) are preferred where conditions permit.

5.5.6.7 Minimum Bottom Slope

Stormwater management ponds shall be constructed with a minimum bottom slope of 1.0% to provide positive drainage to the low flow channel/outlet.

5.5.6.8 Fencing

In general, stormwater management ponds do not require fencing. Construction using specified maximum side slope should allow for safe egress from the stormwater management pond. However, fencing may be required at inlet structures and outlet control structures in some instances.

Select planting and other landscaping features are a preferred access deterrent and a means of providing natural visual screening of the stormwater management pond.

Contingent upon location and proximity to private properties or lands for public purposes, fencing may be required as a matter of public safety and as determined by the Municipality.

In instances where fencing is required, fencing shall be 2.44m (8ft.) high chain link wire mesh.

5.5.6.9 Access Road

Maintenance access roads shall be provided to access the stormwater management pond including all inlet structures, outlet control structures, and emergency overflow structures.

The base gravels are to be a minimum of 150mm of Type 2 gravel and 150mm of Type 1 gravel to a minimum width of 4.0m. Where grades exceed 6%, the surface shall be paved with 75mm Type D-HF asphalt.

If a full loop road is not proposed, a turning circle, or a turning-tee must be provided so that maintenance vehicles may exit the facility without requiring reverse maneuvers.

5.5.6.10 Stormwater Inline Storage

The Municipality may approve the use of oversized in-line pipe storage for stormwater management. If this approach is taken a rider stormwater system may be required to be installed for stormwater service connections for adjacent lots. Street drainage would be directed to the oversized inline pipe storage. Hydraulic grade lines (100 year) are to be shown on the design profiles.

Considerations for design of a constructed wetland or wet ponds for stormwater management may be allowed if it meets the pre / post development flows.

5.6 LOT PLANS FOR BUILDING PERMIT

The builder shall submit with the building permit application; individual lot plans for each lot, indicating the following:

- Elevations at front and rear lot corners (minimum four corners) and road elevation;
- Existing contours (based on topographic survey);
- Location of storm system and elevations of pipe or ditch invert;
- Location of proposed driveway;
- Location of proposed buildings;
- Finished elevations of buildings on lot (minimum four corners);
- Routing of minor and major storm systems;
- Foundation drain elevations at building and street;
- Driveway culvert size (based on inlet control); and
- Directional arrows showing flow pattern (must be away from building and adjacent buildings)

5.7 EROSION AND SEDIMENTATION CONTROL

An Erosion and Sediment control plan shall be provided in compliance with Provincial regulations and a copy submitted to the Municipal Engineer. The plan shall address measures during construction of roads, services, and houses, as well as long term measures which will be in effect following the completion of development.

During construction, surface water flows across the construction site must be minimized.

The Erosion and Sediment Control Plan, as well as control measures taken, shall comply with the Erosion and Sedimentation Control Handbook for Construction Sites as prepared by the Nova Scotia Department of the Environment and Climate Change (NSECC).

Long term environmental protection measures to be addressed in the subdivision design may include but are not limited to:

- Protection of wetlands and waterways in accordance with NSECC Guidelines;
- Minimization of erosion and sediment transport;
- Protection of outfall areas;
- Utilization of wetland areas for filtration of stormwater run-off; and
- Minimization of disruption to natural watercourses

6.0 SANITARY SEWAGE SYSTEM DESIGN

6.1 SCOPE

The sanitary sewage collection system must meet the requirements of the Municipality before the system will be considered for takeover. The following are minimum requirements to consider in the system design and are intended to provide a directive to the Design Engineer responsible for the design and construction of Municipal Services Systems in the Municipality.

Industrial, institutional, and commercial wastewater must meet the requirements of the Municipalities Sewer By-law. If the strength of the wastewater is greater than domestic wastewater, pre-treatment prior to discharge may be required at the discretion of the Municipal Engineer.

This section specifies the requirements for a central sanitary sewer collection system. A sanitary sewer consists of main lines, laterals, pressure sewers, and appurtenances (including manholes and lift stations) owned and maintained by the Municipality.

In addition to these design criteria, all sanitary sewage systems shall conform to the Atlantic Canada Standards and Guidelines for the Collection, Treatment and Disposal of Sanitary Sewage. No systems shall be constructed until the design has been approved by the Municipal Engineer and by NSECC.

6.2 DESIGN REQUIREMENTS

6.2.1 Gravity Systems

6.2.1.1 General

The sanitary sewage system shall be designed for flows generated from all lands within the Serviceable Area which are naturally tributary to the drainage area as determined from topographic plans. Any lands within the Serviceable Area which are tributary by pumping or regrading, which are at present or anticipated to flow through the design area are to be included in the calculated flows for the system being designed.

With respect to depth of cover and grade of sewer mains, the design of the system shall take into consideration possible future extensions so that, wherever practical, those mains shall be installed at sufficient depth to service adjoining lands.

The sanitary sewage system shall be designed utilizing the standard criteria outlined below unless actual flow measurement has been conducted:

- Design shall be based on an appropriate population density according to intended land use;
- Average Dry Weather Flow shall be calculated on-the-basis-of an allowance of 380 liters per person per day; and

- Design Peak Flow shall be calculated on the basis of an allowance of 1,665 liters per person per day plus an inflow and infiltration allowance of 0.25 litres per second per hectare of area. Subject to approval by the Municipality, the Design Peak Flow allowance can be based on the Harmon Peaking Factor plus an allowance for inflow and infiltration.

6.2.1.2 Pipe

Polyvinyl Chloride (PVC), DR35 shall be used for sanitary sewer main installations in the Municipality, unless otherwise approved by the Municipal Engineer.

6.2.1.3 Hydraulic Design

Sanitary sewer mains shall be designed to convey the calculated Design Peak Flows. The designer shall ensure that surcharging of the system does not occur during such peak flow conditions by taking into consideration such factors as energy loss at manholes. The capacity of the sanitary sewer mains is to be calculated using the "Manning Formula" or an appropriate nomograph. A Manning Roughness coefficient (n) equal to 0.010 shall be used for PVC pipe.

Under Design Peak Flow conditions from the tributary area when fully developed, sanitary sewage flow velocities shall be a minimum of 0.6 metres per second and a maximum of 4.5 metres per second. This requirement shall be waived for the end of pipe systems where the minimum pipe size is used.

Pipes to be sized such that pipe is not more than 80 percent full at peak design flow.

6.2.1.4 Minimum Pipe Size

No sanitary sewer main shall be less than 200mm in diameter.

6.2.1.5 Minimum Slope

Sanitary sewer mains shall have a minimum slope of 1 percent. Under special conditions slopes less than 1 percent may be permitted. Slopes less than 1 percent will be considered only where the depth of flow will be at least 30 percent of the diameter of the pipe for Design Peak Flow. In no case shall the slope be reduced to less than 0.5 percent. Sewer laterals shall have minimum slopes of 2 percent.

6.2.1.6 High Velocity Protection

Where velocities greater than 4.5 metres per second are attained, special provision shall be made to protect against displacement by erosion and shock.

6.2.1.7 Depth

In general, the sanitary sewer shall be installed at a sufficient depth to provide service by gravity flow to all proposed lots within the proposed subdivision and provide service to adjoining lands.

The depth of sanitary sewer mains shall not normally exceed a maximum of 4.5m. However, under special conditions, if full and justifiable reasons are given (such as elimination of a pumping station), the maximum depth of sanitary sewer mains may be increased to 5.5m with approval of the Municipal Engineer. To minimize future maintenance costs, all services laterals shall be eliminated from the deep section of the sewer main either by installation of a rider sewer for lateral connections or by the installation of all laterals at manholes.

The minimum depth of sanitary sewer mains shall not be less than 1.5m without approval of the Municipal Engineer. The depth of the sanitary sewer laterals shall not be less than 1m. In general, sewer mains shall be sufficiently deep so to receive sewage from basements and to prevent freezing.

6.2.1.8 Location

Where possible, all sanitary sewer pipe and appurtenances shall be located within a street right of way owned by the Municipality or the NSDPW. If approved by the Municipal Engineer, sanitary sewer mains may be installed within an easement granted in favor of the Municipality. The actual width of the easement shall depend upon the depth of any pipelines contained within the easement. The minimum width of any such easement shall be 6m.

All sanitary sewer pipes shall be located as close as possible to the center line of the street or easement. Depending upon the length and location of the easement, the Municipal Engineer may require a travel way to be provided within the easement for access and maintenance purposes.

Where a need is identified by the Municipal Engineer to accommodate future upstream lands naturally tributary to the drainage area, an easement shall be provided from the edge of the street right of way to the upstream limit of the subdivision.

6.2.1.9 Alignment

All sanitary sewer mains shall be laid with a straight alignment between manholes.

6.2.1.10 Manholes

A manhole is to be provided on a sanitary sewer at any change in pipe size, slope, or alignment and at all pipe intersections. The interval between manholes is not to exceed 120m. All manholes shall pass air testing and be wrapped (sides and bottom) with "Blue skin" or equivalent, to seal against infiltration. Manholes to be precast concrete with an adjustable iron frame and cover, frame, and cover to be adjustable. Cover to have one (1) 25mm vent hole. Off street manholes to have bolt down frame and covers.

The following criteria shall be used for pipe elevation and alignment in sanitary sewer manholes to account for hydraulic losses through the manhole:

- Minimum drop across manholes for pipes of similar diameters shall be:
 - Straight run – 30mm
 - Deflections up to 45 degrees – 30mm
 - Deflections 45 to 90 degrees – 60mm
- The crown of a downstream pipe shall not be higher than the crown of an upstream pipe;
- A drop manhole shall be constructed when the vertical drop between pipe inverts in the manhole exceeds 1m; and
- Drop Manholes shall have an:
 - exterior drop when the manhole is 1050mm diameter or
 - interior drop for manholes larger than 1050mm.
 - The minimum internal diameter of a manhole shall be 1050mm.

All sanitary sewer manholes are to be positioned to minimize the infiltration of surface water or ground water. Manholes shall not be located at or near the following locations:

- Drainage ditch or swale invert; or
- Roadway gutters or low points

In some situations where manholes cannot be easily relocated from the areas noted above, the use of berms and/or water-tight frames and covers may be permitted by the Municipal Engineer.

6.2.1.11 Service Laterals

Minimum size for lateral piping shall be 100mm in diameter (white in color). For laterals greater than 100mm, connection to the sewer main shall be made by installing a manhole on the sanitary sewer main (Doghouse Manholes are permitted). All 100mm laterals shall be constructed with white PVC DR28 pipe conforming to CSA standards.

All service laterals shall be installed according to the following provisions:

- In any new subdivision a single sanitary sewer lateral shall be provided by the developer to each existing or potential lot at the time of installation of services. The lateral shall extend from the main to 1.5m past the property line or as directed by the Municipality;
- The lateral connections to the main shall be made using an inline tee, for connections to existing sewers, a saddle may be permitted;
- The lateral shall be laid at a minimum slope of 2 percent;
- Service laterals with total length greater than 30m shall be installed complete with a wye type clean-out in locations approved by the Municipal Engineer. Clean outs to be provided every 30m;
- The depth of sanitary sewer laterals shall not be less than 1m within the street right of way;

- Lot owners must obtain a sewer connection permit from the Municipality before connecting into the system;
- All sewer laterals shall be capped at the lot line and have a 50x100mm wooden marker indicating depth of bury and painted "Green";
- All structures require a "Protection from Backflow" as required the National Plumbing Code (1995);
- A minimum clearance of 450mm shall be provided between wastewater laterals and existing water mains with the wastewater lateral being below the water main;
- All wastewater laterals must be inspected and accepted by the Municipality before backfilling; and
- The invert elevations of wastewater laterals at the property line shall be shown on Tentative Approval Drawings and confirmed on the Record Drawings.

6.2.2 Pumped Systems

6.2.2.1 General

Pumping stations shall be provided when, in the opinion of the Designer and/or Municipal Engineer, a gravity system is neither possible nor economically feasible.

Sewage pumping station structures and electrical and mechanical equipment shall be protected from physical damage from the 1 in 100-year flood. Sewage pumping stations should remain fully operational and accessible during the 1 in 25-year flood.

All enclosures to meet the requirements of NEMA 4. Electrical systems to be in accordance with the Canadian Electrical Code.

6.2.2.2 Private Pumps

Where private or on-site pumps are required, such installations must be designed by a Professional Engineer. The Design Engineer shall indicate on the drawings those locations requiring private pumping installations. Private pumps shall be owned and operated by the property owner. Each property must be independently serviced to the Municipal wastewater main.

6.2.2.3 Joints

Sewer joints shall be designed to minimize infiltration and to prevent the entrance of roots and shall be made in accordance with the manufacture's recommendations.

6.2.2.4 Groundwater Movement

The designer shall assess the possible change in groundwater movement caused by the use of pervious bedding material and shall be responsible for the design of corrective measures to prevent flooding as a result of this groundwater movement.

Clay plugs at services lateral trenches may be required for low lying lots. Trench relief drains shall be incorporated in the design at valleys.

Unless otherwise approved by the Municipal Engineer, all pumping stations, pumps, and force mains shall be designed for the ultimate sanitary sewer flows from the tributary drainage area. In the selection of pumps, both present and future conditions shall be considered, and pump overloading situations avoided.

Design parameters such as the roughness coefficient of pipe and flow volumes can vary over time, and such variances shall be considered in the selection of the pumps.

6.2.2.5 Pumping Stations

a) Wet Well Size

Wet wells are to be designed in accordance with the pump manufacturer's recommendations. For any pumping station, the wet well shall be of sufficient size to allow for a minimum of a fifteen-minute cycle time for each pump. For a duplex station, the volume in cubic meters between pump start and pump stop shall be 0.225 times the pumping rate of one pump expressed in Liters per second. The wet well size and control settings shall be appropriate to avoid heat build-up in the pump motor due to frequent starting and to avoid septic conditions due to excessive detention time. The Municipality may consider alternatives on a case-by-case basis.

b) Pump Manufacturers

The following pump manufacturers are approved for use in sewage pumping stations in the Municipality. Other pump manufacturers may be considered, by the Municipal Engineer, as approved equals.

- Submersible pumps shall be manufactured by "ITT Flygt"; and
- Self priming pumps shall be manufactured by "Gorman Rupp".

Submersible Pumps shall be designed to minimize the deposition of solids in the wet well using flush valves manufactured by ITT Flygt or approved equal (one hydraulically operated flush valve per pumping station).

Pumps shall be designed specifically for pumping raw, unscreened, domestic sanitary sewage (non-clog, solids handling type). All pumps shall be solids handling type complete with electric motors.

c) Emergency Overflows

To prevent or minimize overflows, each pumping station shall be designed with a retention capacity calculated on the basis of peak design flow for a duration related to frequency and length of power outages for the area established by NS Power. In the absence of reliable data regarding the frequency and length of power outages, a minimum retention capacity of 4.5 hours at peak design flow shall be used. An auxiliary power supply may be used as a substitute for retention capacity at the pumping station.

Subject to NSECC approval, an emergency overflow pipe may be provided under the following conditions:

The invert of the emergency overflow of the pumping station must be lower than the lowest wastewater lateral at the property line and high enough to prevent backup into the pumping station from the high-water mark of the receiving watercourse. The emergency overflow pipe must be provided with a normally- open backwater valve conforming to National Plumbing Code of Canada and readily accessible for maintenance. Where public water supplies, shellfish production, or water used for culinary or food processing purposes exist, overflows are not permitted.

Provisions for chlorination and de-chlorination of overflows must be in accordance with NSECC requirements.

d) Safety Precautions

The pumping station and appurtenances shall be designed in such a manner to ensure the safety of operations, in accordance with all applicable Municipal, Provincial and Federal regulations including the Occupational Health and Safety Act. All moving equipment shall be covered with suitable guards to prevent accidental contact.

Equipment that starts automatically shall be suitably designed to ensure that the operators are aware of this condition. Lockout devices shall be supplied on all equipment to ensure that the equipment is completely out of service when maintenance or servicing is being carried out.

e) Phased Development

In situations of phased development, the effects of minimum flow conditions shall be investigated to ensure that the retention time in the wet well will not create an odor or septic problem and that pumping equipment will not operate too infrequently based on the manufacture's recommendations.

f) Pump Selection

Pumping equipment is to be selected to perform at maximum efficiencies under normal operating conditions.

Pumping stations, wet wells, and dry wells are to be designed such that all pumps will operate under a continuous positive prime condition during the entire pump cycle. System head calculations and curves shall be provided for the extreme operating conditions of high and low water levels in the wet well, as well as the normal operating range in the wet well (medium water level). The curve representing the normal operating conditions shall be used to select the pump and motor, however, the pump and motor shall be proven to be capable of operating satisfactorily over the full range of operating conditions.

g) Surcharge

Pumping stations are to be designed such that the incoming sewers will not surcharge under the peak flow conditions.

h) Flow Velocities

Suction and discharge piping shall be sized to carry the anticipated peak flows. Flow velocities shall be:

- Minimum cleansing velocity of 0.8 metres per second; and
- Maximum velocity of 2.0 metres per second.

Regardless of the above conditions, piping less than 100mm in diameter is not acceptable, unless approved by the Municipal Engineer.

i) Piping

Pumping station internal piping shall be either PVC piping, Schedule 80, HDPE or stainless steel, Type 316 or 316L, 11 Gauge. Regular steel pipe spool pieces are not permitted.

Pressed or rolled Vanstone neck flanges shall be used for all stainless-steel pipe joints, fittings, and connections. All piping within the pumping station shall be properly supported and shall be designed with appropriate fittings to allow for expansion and contraction, thrust restraint, etc.

j) Inlet Arrangements

Only one inlet shall be permitted. If more than one inlet pipe flows into the wet well, a manhole shall be provided outside of the lift station to collect the flow from contributing mains.

k) Hydraulic Analyses

A hydraulic transit analysis shall be undertaken to ensure that transients (water hammer) resulting from pumps starting, stopping, full load rejection during power failure; etc. do not adversely affect the pipe or valves in the system.

l) Valves

Hand operated gate or plug valves must be provided on discharge and suction piping to allow for proper maintenance. A check valve shall be provided on the discharge lines between the isolation gate valve and the pump. Check valves shall be accessible for maintenance.

m) Wet Well Ventilation

A ventilation system capable of delivering a complete air change to the wet well in 10 minutes or delivering fresh air to the wet well at a minimum rate of 110 L/s at 2.0 kPa static pressure, whichever is greater, shall be provided. A separate circuit with a ground fault interrupter shall be provided for the fan. The ventilation fan shall be controlled by a switch at the pumping station control panel set to operate when the control panel door is opened. The ventilation fan control shall also provide for automatic operation of the fan at least 4 times during a 24-hour period. The operation duration of each time shall be adjustable and shall be 10 minutes minimum. The ventilation fan shall be mounted on the pumping station control panel mounting structure adjacent to the control panel. Above ground ventilation

pipng must be stainless steel and must be goose-necked with a bird screen on the open end.

Continuous ventilation shall provide a complete change of air in not more than 5 minutes and intermittent ventilation shall provide a complete change in not more than 2 minutes as per NSECC requirements.

n) Access and Removal

Adequate access hatchways and doorways shall be provided. All pumping stations shall be provided with an acceptable device for the removal of pumps and motors for repair and maintenance. Submersible pumps shall be readily removable and replaceable without dewatering the wet well or disconnecting any piping in the wet well.

Lift hatches must be able to be "locked-in" in the upright position.

A non-corroding working platform shall be constructed in the wet well of each submersible station to provide access to check valves and gate valves. The platform shall be set on a concrete lintel cast integrally with the station walls. Alternatively, a separate valve chamber shall be provided.

All locks shall be keyed alike to the Municipality standard system.

o) Pumping Arrangements

All pumping stations shall have a minimum of two pumping assemblies. If only two pumps are provided, they each shall have the same capacity, with each pump capable of handling the expected Design Peak Flow. Where three or more units are provided, they shall be designed to fit actual flow conditions and must be of such capacity that, with any one unit out of service, the remaining units will have capacity to handle maximum sewage flows, taking into account head losses with parallel operation.

The pump control circuitry shall be designed to automatically alternate pumps for each pump cycle. Run time meters shall be provided to record run time for two pumps operating simultaneously.

p) Electrical

Electric motors less than 7.5 kilowatts (10 horsepower) shall be 208-volt, 3 phase; electric motors, 7.5 kilowatts (10 horsepower) and larger shall be 600 volt, 3 phase.

Single phase pumps will be permitted only if in the opinion of the Municipal Engineer three phase power is not feasible.

All pumping station control equipment is to be mounted in a CSA approved NEMA 4X stainless steel enclosure that is watertight, and heated. Alternatively, control equipment may be mounted in an aboveground, packaged valve enclosure as manufactured by Gorman Rupp. The Municipality currently operates a Supervisory Control and Data Acquisition (SCADA) system for its pumping stations; therefore, each installation shall be

equipped with a pump controller complete with communications hardware, including but not limited to telephone sim card, power supply, antenna and interface cable. Communication software shall be provided and must be fully compatible with the current central monitoring system presently in use in the Municipality.

Electrical service between the control panel and the wet well shall be by way of buried conduit a minimum size of 50mm, shall be sealed gas tight using EYS Conduit Sealing fittings (Explosion-proof) or approved equal and an approved junction box. Each pump cable shall be installed in a separate conduit and a spare conduit shall be provided for future use. All conduits entering or leaving must be adequately sealed to protect against corrosion from harmful gases.

The SCADA unit shall have two extra digital points and two extra analog points and shall be capable of transmitting the following signals and alarms to the monitoring system for that location:

- Hand-off-automatic selector switch status;
- Output control through SCADA system;
- Low level alarm;
- High level alarm;
- Panic alarm on panel support structure;
- Power failure alarm;
- Illegal entry alarm;
- Pump information (overload, motor current, pump status and phase monitoring);
and
- Any other information at the request of the Municipal Engineer.

Specifications shall be provided complete with SCADA requirements.

q) Site Considerations

All pumping stations and control panels must be located off the street ROW in an appropriate area specifically designated for that purpose. The panel back shall face the road to minimize damage due to road salt. The property on which these facilities are located shall be sized to accommodate proper access, maintenance and all features associated with the station. The pumping station shall not be sited in a floodplain. The ownership of this property shall be deeded to the Municipality. All pumping station land shall be graded such that ponding of water does not occur. All exposed areas shall be sodded. The station shall blend into the anticipated surrounding development. An access driveway accepted by the Municipal Engineer shall be provided for access to the pumping station. The driveway shall be constructed of 100mm of Type 1 gravel over 200 mm of Type 2 gravel (at a minimum) to a minimum width of 3.7 m and a minimum length of 7.6 m; an adequate turning area for service vehicles shall be provided.

- r) Operations and Maintenance Manual
Pumping station operations and maintenance manual must be prepared in a form acceptable to the Municipal Engineer and provided to the Municipal Engineer prior to acceptance of the pumping station. This manual must contain at least the following:
- System description;
 - Design parameters, system hydraulics and design calculations (including curves);
 - As constructed civil, mechanical, and electrical drawings;
 - Pump literature, pump curves and operating instructions;
 - Manufacturer's operation and maintenance instructions of all equipment;
 - Name, address, and telephone number of all equipment suppliers and installers; and
 - Information on guarantees/warranties for all equipment. All special tools and standard spare parts for all pumping station equipment are to be provided by the contractor prior to acceptance of the system by the Municipal Engineer.

6.2.2.6 Force Main

- a) Pipe
PVC DR21 and High-Density Polyethylene (HDPE) DR11 are approved for use for sanitary sewer force mains in the Municipality. Pipe shall be designed and installed as per the recommendations of the manufacturer including thrust blocks and mechanical restraints. The Design Engineer is to confirm pipe pressure ratings for specific application.
- Force main shall be clearly marked with trench tape as "Force main" or "Sewer" if installed near a water main of the same material.
- b) Valves
To prevent air locks in the pipe, automatic air relief and vacuum valves shall be located in a chamber at all high points of the force main system or in such other locations as directed by the Municipal Engineer. The hydraulic losses in the force main shall be calculated using the Hazen-Williams Formula or an appropriate nomograph assuming a roughness coefficient of $C = 120$ for any type of pipe material.
- c) Limiting Velocities
The force main shall be designed such that a minimum cleansing velocity of 0.6 metres per second is maintained. The maximum velocity in any force main shall not exceed 2.4 metre per second. Regardless of the above conditions, piping less than 100mm in diameter is not acceptable, unless approved by the Municipal Engineer.
- d) Minimum/Maximum Depths
Force mains shall have a minimum cover of 1.5m and a maximum cover of 2.4m. The depth of cover shall be measured from the design grade at finished surface to the crown of the pipeline.

- e) Slope
Force main slope does not significantly affect the hydraulic design or capacity of the pipeline itself. Under no circumstance, however, shall any force main be installed at zero slope. Zero slope installation makes line filling and pressure testing difficult and promotes accumulation of air and wastewater gases.
- f) Location
Force mains shall not be located in a common trench with a water main. The soil between the mains shall be undisturbed. Force mains crossing water mains shall be laid to provide a minimum vertical distance of 450mm between the outside of the force main and the outside of the water main. The water main shall be above the force main. At crossings, one full length of water pipe shall be located so both joints will be as far from the force main as possible. Special structural support for the water main and force main may be required.
- g) Termination
Force mains should enter the gravity sewer system at a point not more than 0.6m above the flow line of the receiving manhole. A 45-degree bend may be considered to direct the flow downward.
- h) Changes in Direction
Any change in direction which is in excess of the pipe joint deflection tolerance shall require a suitable fitting as approved by the Municipal Engineer. Thrust blocks shall be provided at any change of direction and shall be designed considering the operating pressure, surge pressure, peak flow velocity, and in-situ material which the thrust block bears against.

Thrust blocks shall be constructed of "ready mix" concrete and shall have a minimum 28-day compressive strength of 25MPa. In the case of vertical bends, the thrust block shall be located below the fitting and shall be connected to the force main using stainless-steel tie rods securely embedded in concrete. The use of restrained joints is not permitted unless used in conjunction with a thrust block and of a design acceptable to the Municipal Engineer.

7.0 WATER DISTRIBUTION SYSTEM DESIGN

7.1 SCOPE

This section specifies the requirements for a central water distribution system. A water distribution system consists of water mains, laterals, and appurtenances, including pumping / booster stations, pressure control facilities, and reservoirs, which is designed to carry and distribute an adequate supply of potable water for domestic, institutional, commercial, industrial, and fire protection purposes.

Reference standards and organizations supported by these specifications include:

- Atlantic Canada Water Supply Guidelines prepared by ACWWA;
- "Water Supply for Public Fire Protection" prepared by the Fire Underwriters Survey;
- National Fire Protection Association (NFPA);
- American Water Works Association (AWWA);
- Canadian Standards Association (CSA);
- National Building Code (NBC);
- National Plumbing Code (CPC); and
- Underwriters Laboratories of Canada (ULC).

In addition, all water distribution systems shall conform to any requirements established by NSECC. No system shall be constructed until the design has been approved by the Municipal Engineer and by NSECC.

Water quality is monitored and maintained by the Municipality, and the system must be designed such that the quality is maintained and distributed to the customers at an adequate pressure to supply their needs.

7.2 DESIGN REQUIREMENTS

7.2.1 System Requirements

Water distribution systems shall be designed to accommodate fire flow plus maximum daily demand unless otherwise approved by the Municipal Engineer. Hydraulic analysis of any system shall be carried out by the Design Engineer using the Hydraulic Grade Line for that particular Serviceable Area.

Fire flow demand shall be established in accordance with the latest requirements contained in "Water Supply for Public Fire Protection".

Residential water distribution systems shall be designed to accommodate the following water demands:

- Average daily demand: 410 liters per capita per day;
- Maximum daily demand: 680 liters per capita per day; and
- Maximum hourly demand: 1025 liters per capita per day.

Water distribution systems shall be designed for a gross population density of 45 persons per hectare. In developments where the anticipated population exceeds or is anticipated to exceed the population density of 45 persons per hectare or in areas of commercial or industrial development, the domestic demand shall be adjusted accordingly. The design population or assumed domestic demand must be clearly specified in the calculations submitted for review and approval.

7.2.2 Minimum / Maximum Pressure

Water distribution systems shall be designed and sized such that during a fire flow condition a residual positive pressure of 150 kPa (22psi) is maintained at all points in the water system.

For any water system extension, minimum residual water pressure of 275 kPa (40psi) at all points along the distribution mains in the water system during maximum hourly demand conditions shall be maintained unless approved otherwise by the Municipality. Maximum water pressure during minimum demand periods shall not exceed 620 kPa (90psi) unless approved otherwise by the Municipal Engineer. Where pressures exceed 620 kPa (90psi), private pressure reducing valves (PRVs) may be required.

Calculations to determine residual water pressure shall be based on the Hydraulic Grade Line of the water distribution system.

7.2.3 Pipe

The following types of pipe are approved for use as water mains when installed in accordance with the manufacturer's recommendations and these Municipal standards:

- Polyvinyl Chloride (PVC) Pipe
 - PVC pipe to AWWA C900, PC 235, DR18.
 - PVC pipe is approved for installation in all available diameters.
 - Valves, hydrants, and metallic fittings shall be installed with an attached zinc anode Z- 12-24 to ASTM B418 Type II.
 - Fittings for PVC pipe to AWWA C104, C111 and C153.
 - Tapping sleeves for branch lines over 50 mm diameter to AWWA C223, Type 304 and 304L stainless steel.
 - PVC pipe installation shall include the installation of an approved trace wire system for location purposes.
 - Water lateral taps up to 50 mm diameter must be completed using an approved saddle; direct tapping is not permitted. Wet tapping of PVC pipe is not permitted when the pipe or ambient trench temperature is below 4°C. Adjacent taps in the same pipe length must be staggered circumferentially and separated by a minimum of 450 mm longitudinally. No taps are permitted within 600 mm of the pipe bell or spigot insertion line.

- Molecularly Oriented Polyvinyl Chloride (PVCO) Pipe
 - PVCO pipe to AWWA C909, PC 235.
 - PVCO pipe is approved for installation in all available diameters.
 - Valves, hydrants, and metallic fittings shall be installed with an attached zinc anode Z-12-24 to ASTM B418 Type II.
 - Fittings for PVCO pipe to AWWA C104, C111 and C153.
 - Tapping sleeves for branch lines over 50 mm diameter to AWWA C223, Type 304 and 304L stainless steel.
 - PVCO pipe installation shall include the installation of an approved trace wire system for location purposes.
 - Water lateral taps up to 50 mm diameter must be completed using an approved saddle; direct tapping is not permitted. Wet tapping of PVCO pipe is not permitted when the pipe or ambient trench temperature is below 4°C. Adjacent taps in the same pipe length must be staggered circumferentially and separated by a minimum of 450 mm longitudinally. No taps are permitted within 600 mm of the pipe bell or spigot insertion line.

- Ductile Iron (DI) Pipe
 - DI pipe to AWWA C151, Class 52, cement mortar lined.
 - DI will be considered for installation over 300 mm diameter subject to acceptance by the Municipal Engineer.
 - DI pipe and fittings must be installed with polyethylene encasement.
 - Valves, hydrants, and fittings shall be installed with an attached zinc anode Z-12-24 to ASTM B418 Type II.
 - DI pipe is not approved for installation below the salt water tidal zone.

The Hazen-Williams Formula or an appropriate nomograph using a pipe friction factor of $C = 120$ for PVC and $C = 100$ for ductile iron shall be used in the design calculations of the water distribution system.

7.2.4 Limiting Velocities

The water main shall be sized such that the maximum velocity in the pipe shall not exceed 1.5 metres per second during maximum hourly domestic flow conditions or 3 metres per second during fire flow conditions.

7.2.5 Looping

Water distribution systems shall be designed to provide looping of water mains and interconnection with adjacent developments as frequently as road and service easement layout permit. Additional looping may be required to increase the reliability of the system where a need is identified by the Municipal Engineer. Dead- end pipes shall be avoided where possible.

7.2.6 Minimum Sizes

The water distribution system shall be sized as outlined in the above clauses. However, in no instance shall the main be:

- Smaller than 150mm in diameter for looped lines.
- Smaller than 200mm in diameter for dead-end lines in excess of 90m in length.

7.2.7 Over Sizing

Over sizing of water mains to accommodate the water supply requirements of future off-site development may be required as instructed by the Municipal Engineer.

7.2.8 Minimum / Maximum Cover

All water mains shall be designed with a minimum cover of 1.5m in common material or at suitable depth to prevent freezing of either the water main or the services. In no situation is the depth of cover over the water main to exceed 2.4m unless approved by the Municipal Engineer.

The depth of cover shall be measured from the design grade at finished surface to the crown of the pipeline.

7.2.9 Location

- Water mains shall be installed at a uniform grade of not less than 0.4 % to avoid localized high points unless accepted otherwise by the Municipal Engineer. Water mains shall be installed in the same trench as gravity wastewater and stormwater pipes and must maintain a minimum 300 mm horizontal and vertical clearance from wastewater and stormwater mains with the water main at the higher elevation. If this clearance cannot be achieved, water mains must be installed in a separate trench with a minimum of 3.0 m undisturbed soil between the trenches.
- Water mains must maintain a minimum clearance of 300 mm from manholes. Manholes shall be insulated adjacent to the water main where the clearance is less than 1.2 m.
- Whenever wastewater and stormwater mains must cross under water mains, a clearance of at least 450 mm must be maintained between the wastewater/stormwater main and the water main. When the elevation of the wastewater/stormwater main cannot be varied to meet this requirement, the water main shall be relocated to provide this clearance and reconstructed with restrained fittings for a distance of 3.0 m on each side of the wastewater/stormwater main. One full length of water main shall be centered over the wastewater/stormwater main. Concrete thrust blocks shall be used at all bends.

- When it is not possible to obtain proper horizontal and vertical clearance as stipulated above, the wastewater and stormwater mains shall be designed and constructed to water main standards. This requirement shall apply to catch basin leads as well.
- Water mains must be located within the public street right of way or within a service easement. Service easements must be a minimum width of 6.0 m in favor of the Municipality. Depending on the length and location of the service easement, an appropriate access road may be required for maintenance and operation purposes. Where service easements contain multiple services, the easement must be a minimum width of 6.0 m plus the distance between pipes.
- Water mains shall be installed in a straight line within the traveled way portion of the street right- of- way. On existing streets without curb and gutter, the water main may be installed within the gravel shoulder area at the discretion of the Municipal Engineer.
- Changes in alignment shall be accomplished by the use of manufactured bends. Minor curvature of pipe at joints may be permitted under certain site conditions at the discretion of the Municipal Engineer. Deflection must be within tolerances recommended by the pipe manufacturer.
- Where there is a need to facilitate future development on adjacent lands, water mains shall be extended to the limit of the property boundary.

7.2.10 Valves

All connections to an existing water system shall be valved so that the system can be isolated by the valve at the start of the extension. The connection to the existing water system must be coordinated through the Municipality.

All water system valves shall be mechanical joint, double disc, or resilient seal gate valves and shall conform to AWWA standards. All valves must be accessible through valve boxes or chambers.

Valves shall be provided on the water mains at the following locations:

- Where required to adequately isolate sections of the water system as determined by the Municipal Engineer;
- Four valves per cross, one on each leg;
- Three valves per tee intersection, one on each leg; and
- One valve per 400m of water main where there are no intersections.

7.2.11 Trench Drainage Relief Systems

The designer shall assess the possible change in groundwater movement caused by the use of pervious bedding material and shall be responsible for the design of corrective measures to prevent flooding as a result of this groundwater movement. Water mains installed in a single trench or in areas where sanitary sewer and/or storm sewer mains are not installed shall require a "Trench Drainage Relief System" to lower the hydraulic grade line of the groundwater in the trench below the invert of the water main.

7.2.12 Changes in Direction

Any change in direction which is in excess of the pipe joint deflection tolerance shall require a suitable fitting as approved by the Municipal Engineer. Thrust blocks shall be provided at any change in direction and shall be designed considering the operating pressure, surge pressure, peak flow velocity and in-situ material which the thrust block bears against. Thrust blocks shall be constructed of "ready mix" concrete and shall have a minimum 28-day compressive strength of 25MPa.

In the case of vertical bends, the thrust block or anchor shall be located below the fitting. Anchors shall be connected to the water main using stainless-steel tie rods securely embedded in the concrete. The use of restrained joints is not permitted unless used in conjunction with a thrust block and of a design acceptable to the Municipal Engineer.

Gradient restraint anchor blocks shall be provided for pipes installed at grades steeper than 16%. Approved thrust restraint shall be provided for valves on PVC pipe over 150mm diameter.

Thrust blocks shall be provided for service lateral connections over 100mm diameter.

7.2.13 Fire Hydrants

Fire hydrants shall be provided at spacing in accordance with the requirements contained in the latest revision of the publication "Water Supply for Public Fire Protection". In no case shall the maximum spacing exceed 150m. The following are desirable hydrant locations:

- At high points of the water main profile unless an automatic air release valve is required at that location;
- At low points of the water main profile;
- At intersections of roads; and
- Near middle of long blocks.

At the end of dead-end streets or cul-de-sacs greater than 90m in length. All fire hydrants shall be Clow/McAvery M67 or approved equal.

Fire hydrant laterals shall have a minimum diameter of 150mm, shall be provided with a gate valve and the hydrant drain is to be plugged. Hydrants to be painted red.

Where a hydrant is to be installed on a street with ditches, a 4m wide driveway with a culvert must be installed to provide access to the hydrant.

Private hydrants shall be installed after the water meter unless approved otherwise by the Municipality.

7.2.14 Air Relief and Vacuum Valves

Air relief valves and vacuum valves shall be installed in a chamber at all significant high points in the distribution system and at such other locations as required by good engineering design practice and as approved by the Municipal Engineer.

7.2.15 Service Lateral

All services shall be installed with a minimum cover of 1.5m in common material or a suitable depth to prevent freezing of the service. Where that depth is not achievable, a method of insulating approved by the Municipal Engineer may be used to achieve the equivalent depth of burial. In no case will the depth of burial be less than 1m.

All water distribution system laterals from the main line to the property line shall be provided by the developer or the property owner. A single service lateral is to be supplied to each existing lot or potential future lot which could be created under the zoning in effect at the time of installation of services. Whenever possible, service laterals shall not be installed in private driveways or other traveled areas.

To avoid high friction losses in service piping, the maximum length of any 19mm diameter service lateral shall be limited to 50m from the curb stop to the house. Services longer than 50m shall require at least 25mm diameter piping.

For services which are longer than 20m, the number of compression couplings used is to be kept to a minimum. Compression couplings shall not be used within 1.5m of the foundation of any serviced building.

All water service connections between the corporation stop and curb stop shall be a minimum of 19mm in diameter, blue PEX or PEXa, or approved equal. The outside diameter of the pipe shall be copper tube size (CTS) and must have a standard dimension ratio (SDR) of 9.

Services for future development are to be brought to the property line as directed by the Municipality, capped, and marked with a 50mm x 100mm member painted "Blue". Where the lateral is being installed adjacent to a sidewalk the service is to be installed 2m beyond the street line.

7.2.16 Water Meter Chamber

A Water Service Connection that is set back 50m or greater from the public right of way or public easement boundary requires the water meter and backflow prevention device be installed in a private meter chamber, on private property, adjacent to the right of way or easement boundary. Meter chamber to be designed by a licensed Professional Engineer. See Appendix E – Standard Details for standard water meter chamber details (residential and commercial applications).

7.2.17 Backflow Prevention Devices

Backflow prevention devices are required on all new services as per the National Plumbing code (2015). Backflow devices shall also be installed in accordance with the applicable standard specifications on the following types of services:

- Industrial and commercial buildings;
- Apartment buildings larger than four units; and
- Sprinkler services lines.

8.0 STANDARD DETAILS

Details are included in Appendix E – Standard Details:

- Urban Local Road Cross Section
- Rural Local Road Cross Section
- Curb
- Cul de Sac
- Turning Tee
- Sidewalk
- Driveway Ramp
- Pedestrian Ramp
- Walkway
- Guardrail
- Pipe Trench
- Precast Manhole
- Cast in Place Manhole Base
- Precast Headwall
- Fire Hydrant Details
- Air Release/Vacuum Release Valve
- Water Meter Chambers
- Service Laterals
- Clay Plug
- Underdrain
- Private Road Cross Section
- Catch Basin
- Trench Drain
- Service Areas

APPENDIX A – SAMPLE STATUTORY DECLARATION

**CANADA
PROVINCE OF NOVA SCOTIA
COUNTY OF HANTS S.S.**

To: West Hants Regional Municipality

IN THE MATTER OF: the *Canada Evidence Act*

-and-

IN THE MATTER OF: Construction Contract entered into by _____
(Incorporated or Limited), "the Contractor", for the
Construction of:

- Highway
- Water Line
- Sanitary Sewer
- Storm Sewer
- Other: _____

in the _____ subdivision
at _____, Hants County.

I, (Name of Declarant) of (Address), Province of Nova Scotia, do solemnly declare:

1. **THAT** I am President and/or the Secretary or Treasurer of
_____(Incorporated or Limited) named in the contract above mentioned, and as such
have personal knowledge of the facts herein deposed to except where otherwise stated.
2. **THAT** all accounts payable by the Contractor on or before the date hereof with respect to
subcontractors, labour and materials with respect to the above Contract have been paid in full.
3. **THAT** all wages have been paid in full.
4. **THAT** all amounts owing by the Contractor for Workers' Compensation, employee's income tax
deducted at source, employment insurance and Canada Pension Plan deducted from wages and
salaries, and including the employer's portion, vacation pay allowances and all other charges of
whatsoever nature due or payable by reason of the performance of that work covered by the said
Contract have been duly deducted and paid according to law.
5. **THAT** I am authorized by the Contractor to make this declaration on its behalf.

AND I make this solemn declaration conscientiously believing it to be true and knowing that it is of the same force and effect as if made under oath and by virtue of the *Canada Evidence Act*.

DECLARED BEFORE ME at _____)
_____, in the _____)
County of _____,)
Province of Nova Scotia, this _____)
day of _____, A.D., 20____.)

A BARRISTER/COMMISSIONER OF)
THE SUPREME COURT OF NOVA)
SCOTIA)

President and/or Secretary or Treasurer of

(Incorporated or Limited)

A Barrister (Commissioner) of the
Supreme Court of Nova Scotia

President or responsible Official

APPENDIX B – SAMPLE STREET COMPLETION AGREEMENT

This Agreement made this _____ day of _____, 20__.

Between :

_____, a body corporate with head office at _____, in the County of _____ and Province of Nova Scotia.

“the Developer”

OR

_____ (and _____ both) of _____ in the County of _____ and Province of Nova Scotia.

“the Developer”

and

West Hants Regional Municipality, a body corporate pursuant to the Municipal Act, having its chief place of business at 76 Morison Drive, Wentworth Creek, in the County of Hants and the Province of Nova Scotia.

“the Municipality”

Whereas the Developer has applied to the Development Officer of the Municipality for final subdivision approval of lots within the Subdivision (“the Subdivision”) located at _____ in the District of West Hants;

And Whereas the Municipality has agreed to authorize the Development Officer to give final approval to such lots within the Subdivision upon the terms herein provided upon the Developer entering into and carrying out this Agreement.

And Whereas the Municipal Government Act S. 271(5) authorizes a sub-divider to enter into a bond or other security satisfactory to Council to install and provide the streets and other services to the standards set out in the Subdivision By-law.

Witnesses that in consideration of the premises and of the promises and undertakings herein contained the parties agree to and with one another as follows:

**Street
Dedication**

1. The Developer will forthwith convey to the Municipality any roads, streets or highway within the Subdivision required to be so conveyed together with any required easements or right-of-ways and will simultaneously cause its solicitor to provide a certificate of title to the

Municipality that the Developer has good title to such roads, street or highways, easements and right-of-ways free and clear of encumbrances, and this certificate shall be satisfactory to the Municipality, and that the Developer (has corporate capacity and) has taken all required actions to authorize the execution and delivery to the Municipality of the deed of the said roads, streets or highways, easements and right-of-ways.

Security

2. The Developer will provide to the Municipality cash, certified cheque, bond or irrevocable letter of credit for street completion and for deficiencies in accordance with the requirements of the Subdivision By-law of the Municipality, which security shall be satisfactory to Counsel acting on behalf of the Municipality.

Amount of Security

3. The amount of the security referred to in paragraph 3 shall be 110% of the cost of construction, as estimated by the Engineer, and in any event shall be not less than \$

Completion Date and Requirements

4. The Developer will within 30 days of completion of construction of the roads, streets or highways referred to herein, which completion of construction will be completed by no later than _____ 20__ “the Completion Date”, provide to the Development Officer a certificate of a licensed Professional Engineer (Civil) that the roads, streets or highways meet all standards of the Subdivision By-law and the Municipal Services Specification Manual of the Municipality.

Approval by Development Officer

5. The Municipality will authorize the Development Officer, subject to compliance by the Developer with all relevant matters specified in the Subdivision By-law other than as dealt with herein, to grant final approval to the lots within the Subdivision qualifying for approval under this Agreement.

Acceptance of Dedication

6. The Municipality will accept dedication of the roads, streets or highway together with required easements and right-of-ways.

Steps on Default

7. If the Developer fails to complete the said work by the Completion Date, all security deposited by the Developer is forfeited. The Municipality may serve notice on the Developer by registered mail posted at Windsor, Nova Scotia and addressed to the Developer at Nova Scotia _____, requiring the Developer to proceed with said work immediately.

**Right
to Cure**

8. If the Developer fails to complete said work forthwith or within thirty days after the service of such notice, the Municipality may complete the work pursuant to the direction of the Engineer at the expense of the Developer. The cost of such work completed by the Municipality shall be certified by the Engineer and shall be due and payable by the Developer immediately upon the completion of work.

**Rights on Default
in Performance**

9. If said sum so due and payable is not paid by the Developer to the Municipality immediately, the same may be realized out of the security held by the Municipality hereunder and any balance may be sued for in any court of competent jurisdiction and the Developer shall be responsible for the payment of the same together with costs on a solicitor and client basis.

**Release of
Security**

10. Upon the completion of the said work by the Developer and the approval of the same by the Engineer appointed by the Municipality, and upon compliance with all other terms of this agreement by the Developer and payment of all sums of money owing to the Municipality under the terms of this agreement, any security delivered to the Municipality under Section 3 of this agreement or any agreement collateral hereto shall be released.

**Maintenance
Agreement**

11. The Developer agrees to maintain and keep in good repair the streets and services to a level prescribed by the Subdivision By-law (which streets were constructed by the Developer and conveyed to the Municipality) for a period of one year from the date all of the said streets and all work contemplated by this agreement is finally completed and the Subdivider agrees to abide by any direction reasonably made by the Engineer regarding such maintenance and repair. This maintenance and repair obligation does not include removal of snow and ice which is the responsibility of the Municipality. Any wear and tear of the street caused by use or maintenance activities (i.e., ice and snow removal) shall be repaired by the Developer prior laying of asphalt.

**Maintenance
Bond**

12. The Developer will also upon request by the Development Officer post a maintenance bond or bonds in favour of the Municipality as contemplated by s. 44 (a) of the Subdivision By-law. Such security shall be in the form of cash, certified cheques, bond or irrevocable letter of credit satisfactory to Council acting on behalf of the Municipality, and shall be provided to the Municipality as follows:

- (a) a maintenance bond in the amount of 10% of the actual cost of construction and installation of the water and sanitary sewer

services, to be held by the Municipality for a period of one year from the date of this Agreement; and

- (b) a maintenance bond in the amount of 10% of the actual cost of construction of the roads, streets or highways referred to herein, to be held by the Municipality for a period of one year from the Completion Date referred to in this Agreement.

Steps on Default of Maintenance Agreement

13. If the Developer fails to maintain the streets and services as provided in Section 11 of this Agreement, all security deposited by the Developer is forfeited. The Municipality may serve notice on the Developer by registered mail addressed to the Developer, requiring the Developer to proceed with the said work immediately. If the Developer fails to complete said work within thirty days after the service of such notice, the Municipality may complete the work under the direction of the Engineer at the expense of the Developer. The cost of such work completed by the Municipality shall be certified by the Engineer and shall be due and payable by the Developer immediately upon the completion of the work.

If said sum so due and payable is not paid by the Developer to the Municipality immediately, the same may be realized out of the security held by the Municipality hereunder and any balance may be sued for in any court of competent jurisdiction and the Developer shall be responsible for the payment of the same together with costs on a solicitor and client basis.

Settlement of Disagreement

14. Should the parties hereto disagree as to whether the said work or maintenance is being done or has been done in accordance with the said regulations or with due diligence, the matters in dispute shall be referred to the Engineer whose decision shall be final and binding upon the parties hereto.

A certificate signed by the Engineer disclosing the Developer's failure to complete the work or maintenance contemplated by this agreement shall be conclusive evidence that the Developer has breached this agreement and the Municipality therefore is entitled to realize on its security as provided herein.

Ownership

15. The Developer covenants with the Municipality that it is the owner in fee simple of the lands referred to herein, that they are free from all encumbrances, that the Developer has the right to convey the same and the Developer shall procure such further assurances as may be reasonably required.

Remedies

16. The Municipality may, in its sole discretion, grant extensions of time for completion of work by the Developer without in any way releasing the Developer from its obligations pursuant to the terms of this Agreement, and nothing but the actual completion of the work set forth in this Agreement shall release the Developer from its liability. All rights of the Municipality are cumulative and the taking of one action by the Municipality shall not act as a merger of the other rights of the Municipality pursuant to the terms of this Agreement.

Time

17. Time shall be the essence of this Agreement.

Benefit and Binding

18. This Agreement shall enure for the benefit of and be binding upon not only the parties hereto but also their respective heirs, representatives, successors and assigns.

IN WITNESS WHEREOF the Developer and the Municipality have executed this Agreement the day and year first above written.

SIGNED, SEALED AND DELIVERED

| | |
|---------|------------------------------------|
| |) _____ (Developer) |
| |) |
| |) |
| |) Per: |
| |) |
| _____ |) Per: |
| Witness |) |
| |) |
| |) WEST HANTS REGIONAL MUNICIPALITY |
| |) |
| |) Per: |
| |) |
| _____ |) Per: |
| Witness |) |

APPENDIX C – SAMPLE LETTER OF CREDIT

LETTER OF CREDIT

NAME OF BANK: _____ Date Issued: _____

Branch: _____

Letter of Credit No. _____ Amount: _____

Issued subject to the Uniform Customs and Practices for Documentary Credits being ICC Publication UCP 500.

TO: West Hants Regional Municipality

ADDRESS: 76 Morison Drive (P.O. Box 3000) Windsor, Nova Scotia B0N 2T0

WE HEREBY AUTHORIZE YOU TO DRAW ON THE

(Name of Bank), being a Schedule 1 or Schedule 2 chartered bank
for the account of _____

(Name of Customer)

UP TO AN AGGREGATE AMOUNT OF _____
Dollars (\$ _____) available on demand.

PURSUANT TO THE REQUEST OF our Customer: _____
we the _____

(Name of Bank)

hereby establish and give you an irrevocable Letter of Credit in your favour in the above amount which may be drawn on by you at any time and from time-to-time, upon written demand for payment made upon us by you which demand we shall honour without enquiring whether you have the right as between yourself and the said Customer to make such demand, and without recognizing any claim of our said Customer, or objection by it to payment by us.

DEMAND shall be by way of a Letter signed by the Clerk of the Municipality under the corporate seal attached to which shall be the original Letter of Credit. Presentation shall be made to the Bank at: _____

(Address)

THE LETTER OF CREDIT we understand relates to those Municipal services and financial obligations set out in an Agreement between the Customer and the Municipality and referred to as:

_____ (Name of Project or Agreement)

THE AMOUNT of this Letter of Credit may be reduced from time-to-time as advised by notice in writing to the undersigned by the Clerk of the Municipality.

THIS LETTER OF CREDIT will continue in force for a period of one year, but shall be subject to the condition hereinafter set forth.

IT IS A CONDITION of this Letter of Credit that it shall be deemed to be automatically extended without amendment from year-to-year from the present or any future expiration date hereof, unless at least 30 days prior to the present or any future expiration date, we notify you in writing by registered mail that we elect not to consider this Letter of Credit to be renewable for any additional period.

DATED at _____, Nova Scotia this _____ day of _____, A.D., 20 _____.

COUNTERSIGNED BY: _____ (NAME OF BANK)

Per _____

Authorized Signing Officer

APPENDIX D – SAMPLE CLOSE-OUT REPORT CHECKLIST



West Hants Regional Municipality

Subdivision Final Approval Close-Out Report

| SECTION | DESCRIPTION | WHRM SPECIFICATION | PROVIDED BY | RECEIVED BY WHRM |
|---------|--|--------------------|----------------------|------------------|
| A | Application for Final Approval | 3.3.1.2 | Development Officer | |
| | Final Plan of Subdivision | 3.3.1.3 | Developer's Engineer | |
| B | Certificate of Compliance | 3.3.1.4 | Developer's Engineer | |
| C | Statement of Construction Costs | 3.3.1.4 | Developer's Engineer | |
| | Statutory Declaration | 3.3.1.4 | Developer | |
| | Maintenance Bond – 10% of Cost of Infrastructure | 3.3.1.4 | Developer | |
| | Deficiency List | 3.3.2.2 | Developer's Engineer | |
| | Deficiency Bond – 150% of Uncompleted Work | 3.3.2.2 | Developer | |
| D | Plan of Streets, Drainage Right-of-Ways, Easements | 3.3.1.5 | Developer's Engineer | |
| E | Warranty Deeds | 3.3.1.6 | Developer | |
| | Easement Plans & Descriptions | 3.3.1.6 | Developer | |
| | Title Certificate | 3.3.1.6 | Developer | |
| F | Operation & Maintenance Manuals | 3.3.1.7 | Developer | |
| G | Inspection & Testing Reports | 3.3.1.8 | Developer's Engineer | |
| H | Record Drawings | 3.3.1.9 | Developer's Engineer | |

Refer to Section 3.3 (Final Plan Approval Submission Requirements) of the *Municipal Services Specifications Manual*, provided by West Hants Regional Municipality, for further information

APPENDIX E – RAINFALL DATA

Intensity Duration Frequency Tables and Curves

$$R = A * T^B$$

R interpolated rainfall rate (mm/hr)

T rainfall duration (hr)

A coefficient

B exponential coefficient

| STORM | A | B |
|--------|------|--------|
| 2-YR | 21 | -0.604 |
| 5-YR | 27.6 | -0.604 |
| 10-YR | 32 | -0.605 |
| 100-YR | 45.6 | -0.605 |

| Duration (hr) | INTENSITY (mm/hr) | | | |
|---------------|-------------------|---------|---------|---------|
| | 2-YR | 5-YR | 10-YR | 100-YR |
| 0.083 | 94.199 | 123.804 | 143.898 | 205.055 |
| 0.167 | 61.976 | 81.454 | 94.609 | 134.818 |
| 0.3 | 48.514 | 63.761 | 74.028 | 105.490 |
| 0.5 | 31.918 | 41.950 | 48.671 | 69.357 |
| 1.0 | 21.000 | 27.600 | 32.000 | 45.600 |
| 2.0 | 13.816 | 18.159 | 21.039 | 29.981 |
| 6.0 | 7.116 | 9.352 | 10.824 | 15.424 |
| 12.0 | 4.682 | 6.153 | 7.116 | 10.141 |
| 24.0 | 3.080 | 4.048 | 4.679 | 6.667 |

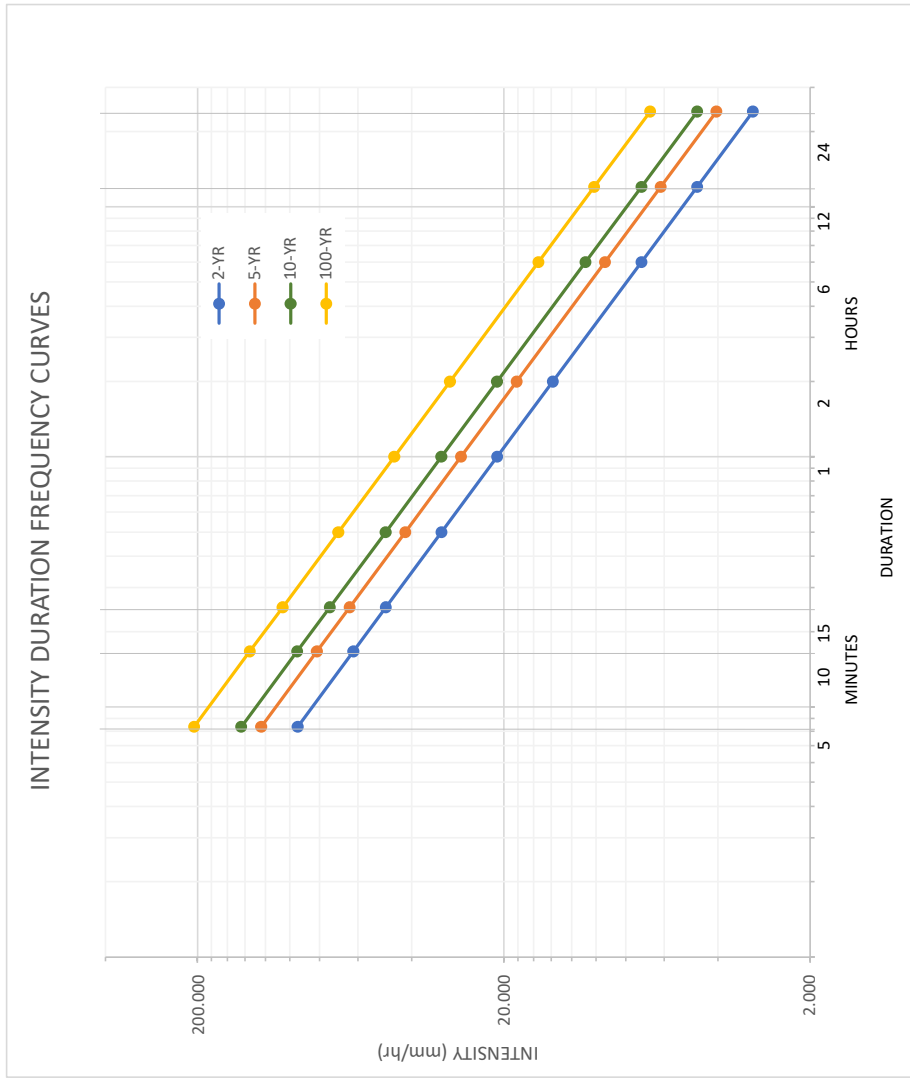

1:2-Year Design Storm: Cumulative Depth Table



| 1:2-YEAR DESIGN STORM | | | | | | | |
|-----------------------|-----------------------|--------------|-----------------------|--------------|-----------------------|--------------|-----------------------|
| Time (hours) | Cumulative Depth (mm) | Time (hours) | Cumulative Depth (mm) | Time (hours) | Cumulative Depth (mm) | Time (hours) | Cumulative Depth (mm) |
| 0.1 | 0.13 | 6.1 | 9.43 | 12.1 | 40.39 | 18.1 | 61.98 |
| 0.2 | 0.26 | 6.2 | 9.62 | 12.2 | 41.80 | 18.2 | 62.17 |
| 0.3 | 0.39 | 6.3 | 9.82 | 12.3 | 42.89 | 18.3 | 62.35 |
| 0.4 | 0.52 | 6.4 | 10.02 | 12.4 | 43.80 | 18.4 | 62.54 |
| 0.5 | 0.65 | 6.5 | 10.21 | 12.5 | 44.60 | 18.5 | 62.72 |
| 0.6 | 0.78 | 6.6 | 10.42 | 12.6 | 45.32 | 18.6 | 62.90 |
| 0.7 | 0.92 | 6.7 | 10.62 | 12.7 | 45.97 | 18.7 | 63.08 |
| 0.8 | 1.05 | 6.8 | 10.82 | 12.8 | 46.58 | 18.8 | 63.26 |
| 0.9 | 1.18 | 6.9 | 11.03 | 12.9 | 47.14 | 18.9 | 63.43 |
| 1.0 | 1.32 | 7.0 | 11.24 | 13.0 | 47.67 | 19.0 | 63.61 |
| 1.1 | 1.45 | 7.1 | 11.45 | 13.1 | 48.18 | 19.1 | 63.78 |
| 1.2 | 1.59 | 7.2 | 11.67 | 13.2 | 48.65 | 19.2 | 63.95 |
| 1.3 | 1.73 | 7.3 | 11.89 | 13.3 | 49.11 | 19.3 | 64.12 |
| 1.4 | 1.86 | 7.4 | 12.11 | 13.4 | 49.55 | 19.4 | 64.29 |
| 1.5 | 2.00 | 7.5 | 12.33 | 13.5 | 49.97 | 19.5 | 64.46 |
| 1.6 | 2.14 | 7.6 | 12.56 | 13.6 | 50.37 | 19.6 | 64.63 |
| 1.7 | 2.28 | 7.7 | 12.79 | 13.7 | 50.77 | 19.7 | 64.79 |
| 1.8 | 2.42 | 7.8 | 13.02 | 13.8 | 51.14 | 19.8 | 64.96 |
| 1.9 | 2.56 | 7.9 | 13.25 | 13.9 | 51.51 | 19.9 | 65.12 |
| 2.0 | 2.70 | 8.0 | 13.49 | 14.0 | 51.87 | 20.0 | 65.28 |
| 2.1 | 2.85 | 8.1 | 13.73 | 14.1 | 52.22 | 20.1 | 65.44 |
| 2.2 | 2.99 | 8.2 | 13.98 | 14.2 | 52.55 | 20.2 | 65.60 |
| 2.3 | 3.14 | 8.3 | 14.23 | 14.3 | 52.88 | 20.3 | 65.76 |
| 2.4 | 3.28 | 8.4 | 14.48 | 14.4 | 53.20 | 20.4 | 65.92 |
| 2.5 | 3.43 | 8.5 | 14.74 | 14.5 | 53.52 | 20.5 | 66.07 |
| 2.6 | 3.57 | 8.6 | 15.00 | 14.6 | 53.82 | 20.6 | 66.23 |
| 2.7 | 3.72 | 8.7 | 15.26 | 14.7 | 54.12 | 20.7 | 66.38 |
| 2.8 | 3.87 | 8.8 | 15.53 | 14.8 | 54.42 | 20.8 | 66.54 |
| 2.9 | 4.02 | 8.9 | 15.81 | 14.9 | 54.71 | 20.9 | 66.69 |
| 3.0 | 4.17 | 9.0 | 16.09 | 15.0 | 54.99 | 21.0 | 66.84 |
| 3.1 | 4.32 | 9.1 | 16.37 | 15.1 | 55.27 | 21.1 | 66.99 |
| 3.2 | 4.48 | 9.2 | 16.66 | 15.2 | 55.54 | 21.2 | 67.14 |
| 3.3 | 4.63 | 9.3 | 16.96 | 15.3 | 55.81 | 21.3 | 67.29 |
| 3.4 | 4.79 | 9.4 | 17.26 | 15.4 | 56.07 | 21.4 | 67.43 |
| 3.5 | 4.94 | 9.5 | 17.57 | 15.5 | 56.33 | 21.5 | 67.58 |
| 3.6 | 5.10 | 9.6 | 17.89 | 15.6 | 56.58 | 21.6 | 67.73 |
| 3.7 | 5.26 | 9.7 | 18.22 | 15.7 | 56.83 | 21.7 | 67.87 |
| 3.8 | 5.42 | 9.8 | 18.55 | 15.8 | 57.08 | 21.8 | 68.02 |
| 3.9 | 5.58 | 9.9 | 18.89 | 15.9 | 57.32 | 21.9 | 68.16 |
| 4.0 | 5.74 | 10.0 | 19.24 | 16.0 | 57.56 | 22.0 | 68.30 |
| 4.1 | 5.90 | 10.1 | 19.61 | 16.1 | 57.80 | 22.1 | 68.44 |
| 4.2 | 6.06 | 10.2 | 19.98 | 16.2 | 58.03 | 22.2 | 68.59 |
| 4.3 | 6.23 | 10.3 | 20.36 | 16.3 | 58.27 | 22.3 | 68.73 |
| 4.4 | 6.39 | 10.4 | 20.76 | 16.4 | 58.49 | 22.4 | 68.87 |
| 4.5 | 6.56 | 10.5 | 21.17 | 16.5 | 58.72 | 22.5 | 69.00 |
| 4.6 | 6.73 | 10.6 | 21.60 | 16.6 | 58.94 | 22.6 | 69.14 |
| 4.7 | 6.90 | 10.7 | 22.05 | 16.7 | 59.16 | 22.7 | 69.28 |
| 4.8 | 7.07 | 10.8 | 22.52 | 16.8 | 59.37 | 22.8 | 69.42 |
| 4.9 | 7.24 | 10.9 | 23.01 | 16.9 | 59.59 | 22.9 | 69.55 |
| 5.0 | 7.42 | 11.0 | 23.52 | 17.0 | 59.80 | 23.0 | 69.69 |
| 5.1 | 7.59 | 11.1 | 24.07 | 17.1 | 60.01 | 23.1 | 69.82 |
| 5.2 | 7.77 | 11.2 | 24.66 | 17.2 | 60.21 | 23.2 | 69.95 |
| 5.3 | 7.95 | 11.3 | 25.29 | 17.3 | 60.42 | 23.3 | 70.09 |
| 5.4 | 8.13 | 11.4 | 25.97 | 17.4 | 60.62 | 23.4 | 70.22 |
| 5.5 | 8.31 | 11.5 | 26.72 | 17.5 | 60.82 | 23.5 | 70.35 |
| 5.6 | 8.49 | 11.6 | 27.58 | 17.6 | 61.02 | 23.6 | 70.48 |
| 5.7 | 8.67 | 11.7 | 28.57 | 17.7 | 61.22 | 23.7 | 70.61 |
| 5.8 | 8.86 | 11.8 | 29.79 | 17.8 | 61.41 | 23.8 | 70.74 |
| 5.9 | 9.05 | 11.9 | 31.50 | 17.9 | 61.60 | 23.9 | 70.87 |
| 6.0 | 9.24 | 12.0 | 38.08 | 18.0 | 61.79 | 24.0 | 71.00 |

Rainfall data from Environment Canada and Climate Change. Rainfall Frequency Atlas Of Canada for Windsor, N.S. amounts include a 15% increase for climate change.

1:5-Year Design Storm: Cumulative Depth Table



| 1:5-YEAR DESIGN STORM | | | | | | | |
|-----------------------|-----------------------|--------------|-----------------------|--------------|-----------------------|--------------|-----------------------|
| Time (hours) | Cumulative Depth (mm) | Time (hours) | Cumulative Depth (mm) | Time (hours) | Cumulative Depth (mm) | Time (hours) | Cumulative Depth (mm) |
| 0.1 | 0.16 | 6.1 | 12.09 | 12.1 | 55.45 | 18.1 | 84.44 |
| 0.2 | 0.33 | 6.2 | 12.34 | 12.2 | 57.45 | 18.2 | 84.68 |
| 0.3 | 0.49 | 6.3 | 12.60 | 12.3 | 58.98 | 18.3 | 84.92 |
| 0.4 | 0.66 | 6.4 | 12.85 | 12.4 | 60.25 | 18.4 | 85.16 |
| 0.5 | 0.83 | 6.5 | 13.11 | 12.5 | 61.35 | 18.5 | 85.39 |
| 0.6 | 1.00 | 6.6 | 13.37 | 12.6 | 62.34 | 18.6 | 85.63 |
| 0.7 | 1.16 | 6.7 | 13.63 | 12.7 | 63.24 | 18.7 | 85.86 |
| 0.8 | 1.33 | 6.8 | 13.90 | 12.8 | 64.06 | 18.8 | 86.09 |
| 0.9 | 1.50 | 6.9 | 14.17 | 12.9 | 64.83 | 18.9 | 86.31 |
| 1.0 | 1.68 | 7.0 | 14.45 | 13.0 | 65.55 | 19.0 | 86.54 |
| 1.1 | 1.85 | 7.1 | 14.72 | 13.1 | 66.23 | 19.1 | 86.76 |
| 1.2 | 2.02 | 7.2 | 15.00 | 13.2 | 66.88 | 19.2 | 86.98 |
| 1.3 | 2.20 | 7.3 | 15.28 | 13.3 | 67.49 | 19.3 | 87.20 |
| 1.4 | 2.37 | 7.4 | 15.57 | 13.4 | 68.08 | 19.4 | 87.42 |
| 1.5 | 2.55 | 7.5 | 15.86 | 13.5 | 68.65 | 19.5 | 87.64 |
| 1.6 | 2.73 | 7.6 | 16.16 | 13.6 | 69.19 | 19.6 | 87.85 |
| 1.7 | 2.90 | 7.7 | 16.46 | 13.7 | 69.71 | 19.7 | 88.06 |
| 1.8 | 3.08 | 7.8 | 16.76 | 13.8 | 70.22 | 19.8 | 88.28 |
| 1.9 | 3.26 | 7.9 | 17.07 | 13.9 | 70.71 | 19.9 | 88.48 |
| 2.0 | 3.45 | 8.0 | 17.38 | 14.0 | 71.18 | 20.0 | 88.69 |
| 2.1 | 3.63 | 8.1 | 17.69 | 14.1 | 71.65 | 20.1 | 88.90 |
| 2.2 | 3.81 | 8.2 | 18.01 | 14.2 | 72.09 | 20.2 | 89.10 |
| 2.3 | 4.00 | 8.3 | 18.34 | 14.3 | 72.53 | 20.3 | 89.31 |
| 2.4 | 4.18 | 8.4 | 18.67 | 14.4 | 72.96 | 20.4 | 89.51 |
| 2.5 | 4.37 | 8.5 | 19.01 | 14.5 | 73.37 | 20.5 | 89.71 |
| 2.6 | 4.56 | 8.6 | 19.35 | 14.6 | 73.78 | 20.6 | 89.91 |
| 2.7 | 4.75 | 8.7 | 19.70 | 14.7 | 74.18 | 20.7 | 90.11 |
| 2.8 | 4.94 | 8.8 | 20.06 | 14.8 | 74.56 | 20.8 | 90.30 |
| 2.9 | 5.13 | 8.9 | 20.42 | 14.9 | 74.94 | 20.9 | 90.50 |
| 3.0 | 5.32 | 9.0 | 20.79 | 15.0 | 75.32 | 21.0 | 90.69 |
| 3.1 | 5.52 | 9.1 | 21.16 | 15.1 | 75.68 | 21.1 | 90.88 |
| 3.2 | 5.71 | 9.2 | 21.55 | 15.2 | 76.04 | 21.2 | 91.08 |
| 3.3 | 5.91 | 9.3 | 21.94 | 15.3 | 76.39 | 21.3 | 91.27 |
| 3.4 | 6.11 | 9.4 | 22.34 | 15.4 | 76.74 | 21.4 | 91.45 |
| 3.5 | 6.31 | 9.5 | 22.75 | 15.5 | 77.08 | 21.5 | 91.64 |
| 3.6 | 6.51 | 9.6 | 23.17 | 15.6 | 77.41 | 21.6 | 91.83 |
| 3.7 | 6.71 | 9.7 | 23.60 | 15.7 | 77.74 | 21.7 | 92.01 |
| 3.8 | 6.92 | 9.8 | 24.05 | 15.8 | 78.07 | 21.8 | 92.20 |
| 3.9 | 7.12 | 9.9 | 24.50 | 15.9 | 78.38 | 21.9 | 92.38 |
| 4.0 | 7.33 | 10.0 | 24.97 | 16.0 | 78.70 | 22.0 | 92.56 |
| 4.1 | 7.54 | 10.1 | 25.45 | 16.1 | 79.01 | 22.1 | 92.74 |
| 4.2 | 7.75 | 10.2 | 25.95 | 16.2 | 79.31 | 22.2 | 92.92 |
| 4.3 | 7.96 | 10.3 | 26.46 | 16.3 | 79.61 | 22.3 | 93.10 |
| 4.4 | 8.17 | 10.4 | 27.00 | 16.4 | 79.91 | 22.4 | 93.28 |
| 4.5 | 8.39 | 10.5 | 27.55 | 16.5 | 80.20 | 22.5 | 93.46 |
| 4.6 | 8.61 | 10.6 | 28.13 | 16.6 | 80.49 | 22.6 | 93.63 |
| 4.7 | 8.82 | 10.7 | 28.73 | 16.7 | 80.78 | 22.7 | 93.81 |
| 4.8 | 9.04 | 10.8 | 29.36 | 16.8 | 81.06 | 22.8 | 93.98 |
| 4.9 | 9.27 | 10.9 | 30.02 | 16.9 | 81.34 | 22.9 | 94.16 |
| 5.0 | 9.49 | 11.0 | 30.72 | 17.0 | 81.61 | 23.0 | 94.33 |
| 5.1 | 9.72 | 11.1 | 31.47 | 17.1 | 81.88 | 23.1 | 94.50 |
| 5.2 | 9.94 | 11.2 | 32.26 | 17.2 | 82.15 | 23.2 | 94.67 |
| 5.3 | 10.17 | 11.3 | 33.12 | 17.3 | 82.42 | 23.3 | 94.84 |
| 5.4 | 10.41 | 11.4 | 34.06 | 17.4 | 82.68 | 23.4 | 95.01 |
| 5.5 | 10.64 | 11.5 | 35.10 | 17.5 | 82.94 | 23.5 | 95.17 |
| 5.6 | 10.88 | 11.6 | 36.28 | 17.6 | 83.20 | 23.6 | 95.34 |
| 5.7 | 11.12 | 11.7 | 37.66 | 17.7 | 83.45 | 23.7 | 95.51 |
| 5.8 | 11.36 | 11.8 | 39.39 | 17.8 | 83.70 | 23.8 | 95.67 |
| 5.9 | 11.60 | 11.9 | 41.84 | 17.9 | 83.95 | 23.9 | 95.84 |
| 6.0 | 11.84 | 12.0 | 52.10 | 18.0 | 84.20 | 24.0 | 96.00 |

Rainfall data from Environment Canada and Climate Change. Rainfall Frequency Atlas Of Canada for Windsor, N.S. amounts include a 15% increase for climate change.

1:10-Year Design Storm: Cumulative Depth Table



| 1:10-YEAR DESIGN STORM | | | | | | | |
|------------------------|-----------------------|--------------|-----------------------|--------------|-----------------------|--------------|-----------------------|
| Time (hours) | Cumulative Depth (mm) | Time (hours) | Cumulative Depth (mm) | Time (hours) | Cumulative Depth (mm) | Time (hours) | Cumulative Depth (mm) |
| 0.1 | 0.19 | 6.1 | 13.90 | 12.1 | 65.72 | 18.1 | 99.71 |
| 0.2 | 0.38 | 6.2 | 14.19 | 12.2 | 68.12 | 18.2 | 99.99 |
| 0.3 | 0.57 | 6.3 | 14.48 | 12.3 | 69.95 | 18.3 | 100.27 |
| 0.4 | 0.76 | 6.4 | 14.78 | 12.4 | 71.46 | 18.4 | 100.54 |
| 0.5 | 0.95 | 6.5 | 15.08 | 12.5 | 72.77 | 18.5 | 100.81 |
| 0.6 | 1.14 | 6.6 | 15.38 | 12.6 | 73.94 | 18.6 | 101.08 |
| 0.7 | 1.33 | 6.7 | 15.68 | 12.7 | 75.00 | 18.7 | 101.35 |
| 0.8 | 1.53 | 6.8 | 15.99 | 12.8 | 75.97 | 18.8 | 101.61 |
| 0.9 | 1.72 | 6.9 | 16.30 | 12.9 | 76.88 | 18.9 | 101.87 |
| 1.0 | 1.92 | 7.0 | 16.62 | 13.0 | 77.73 | 19.0 | 102.13 |
| 1.1 | 2.12 | 7.1 | 16.94 | 13.1 | 78.53 | 19.1 | 102.39 |
| 1.2 | 2.32 | 7.2 | 17.26 | 13.2 | 79.29 | 19.2 | 102.65 |
| 1.3 | 2.52 | 7.3 | 17.59 | 13.3 | 80.01 | 19.3 | 102.90 |
| 1.4 | 2.72 | 7.4 | 17.92 | 13.4 | 80.70 | 19.4 | 103.15 |
| 1.5 | 2.92 | 7.5 | 18.26 | 13.5 | 81.36 | 19.5 | 103.40 |
| 1.6 | 3.12 | 7.6 | 18.60 | 13.6 | 82.00 | 19.6 | 103.64 |
| 1.7 | 3.33 | 7.7 | 18.95 | 13.7 | 82.61 | 19.7 | 103.89 |
| 1.8 | 3.54 | 7.8 | 19.30 | 13.8 | 83.20 | 19.8 | 104.13 |
| 1.9 | 3.74 | 7.9 | 19.65 | 13.9 | 83.78 | 19.9 | 104.37 |
| 2.0 | 3.95 | 8.0 | 20.02 | 14.0 | 84.33 | 20.0 | 104.61 |
| 2.1 | 4.16 | 8.1 | 20.38 | 14.1 | 84.87 | 20.1 | 104.85 |
| 2.2 | 4.37 | 8.2 | 20.75 | 14.2 | 85.39 | 20.2 | 105.09 |
| 2.3 | 4.58 | 8.3 | 21.13 | 14.3 | 85.90 | 20.3 | 105.32 |
| 2.4 | 4.80 | 8.4 | 21.52 | 14.4 | 86.40 | 20.4 | 105.55 |
| 2.5 | 5.01 | 8.5 | 21.91 | 14.5 | 86.88 | 20.5 | 105.78 |
| 2.6 | 5.23 | 8.6 | 22.31 | 14.6 | 87.36 | 20.6 | 106.01 |
| 2.7 | 5.45 | 8.7 | 22.71 | 14.7 | 87.82 | 20.7 | 106.24 |
| 2.8 | 5.66 | 8.8 | 23.13 | 14.8 | 88.27 | 20.8 | 106.46 |
| 2.9 | 5.88 | 8.9 | 23.55 | 14.9 | 88.71 | 20.9 | 106.69 |
| 3.0 | 6.11 | 9.0 | 23.98 | 15.0 | 89.15 | 21.0 | 106.91 |
| 3.1 | 6.33 | 9.1 | 24.41 | 15.1 | 89.57 | 21.1 | 107.13 |
| 3.2 | 6.56 | 9.2 | 24.86 | 15.2 | 89.99 | 21.2 | 107.35 |
| 3.3 | 6.78 | 9.3 | 25.32 | 15.3 | 90.40 | 21.3 | 107.57 |
| 3.4 | 7.01 | 9.4 | 25.78 | 15.4 | 90.80 | 21.4 | 107.79 |
| 3.5 | 7.24 | 9.5 | 26.26 | 15.5 | 91.19 | 21.5 | 108.00 |
| 3.6 | 7.47 | 9.6 | 26.75 | 15.6 | 91.58 | 21.6 | 108.22 |
| 3.7 | 7.70 | 9.7 | 27.26 | 15.7 | 91.96 | 21.7 | 108.43 |
| 3.8 | 7.94 | 9.8 | 27.77 | 15.8 | 92.34 | 21.8 | 108.64 |
| 3.9 | 8.18 | 9.9 | 28.30 | 15.9 | 92.71 | 21.9 | 108.85 |
| 4.0 | 8.41 | 10.0 | 28.85 | 16.0 | 93.07 | 22.0 | 109.06 |
| 4.1 | 8.65 | 10.1 | 29.41 | 16.1 | 93.43 | 22.1 | 109.27 |
| 4.2 | 8.90 | 10.2 | 30.00 | 16.2 | 93.78 | 22.2 | 109.47 |
| 4.3 | 9.14 | 10.3 | 30.60 | 16.3 | 94.13 | 22.3 | 109.68 |
| 4.4 | 9.38 | 10.4 | 31.22 | 16.4 | 94.48 | 22.4 | 109.88 |
| 4.5 | 9.63 | 10.5 | 31.87 | 16.5 | 94.81 | 22.5 | 110.09 |
| 4.6 | 9.88 | 10.6 | 32.55 | 16.6 | 95.15 | 22.6 | 110.29 |
| 4.7 | 10.13 | 10.7 | 33.25 | 16.7 | 95.48 | 22.7 | 110.49 |
| 4.8 | 10.39 | 10.8 | 33.99 | 16.8 | 95.80 | 22.8 | 110.69 |
| 4.9 | 10.64 | 10.9 | 34.77 | 16.9 | 96.13 | 22.9 | 110.89 |
| 5.0 | 10.90 | 11.0 | 35.59 | 17.0 | 96.44 | 23.0 | 111.08 |
| 5.1 | 11.16 | 11.1 | 36.47 | 17.1 | 96.76 | 23.1 | 111.28 |
| 5.2 | 11.42 | 11.2 | 37.41 | 17.2 | 97.07 | 23.2 | 111.48 |
| 5.3 | 11.69 | 11.3 | 38.43 | 17.3 | 97.38 | 23.3 | 111.67 |
| 5.4 | 11.96 | 11.4 | 39.54 | 17.4 | 97.68 | 23.4 | 111.86 |
| 5.5 | 12.23 | 11.5 | 40.77 | 17.5 | 97.98 | 23.5 | 112.05 |
| 5.6 | 12.50 | 11.6 | 42.17 | 17.6 | 98.28 | 23.6 | 112.25 |
| 5.7 | 12.77 | 11.7 | 43.82 | 17.7 | 98.57 | 23.7 | 112.44 |
| 5.8 | 13.05 | 11.8 | 45.88 | 17.8 | 98.86 | 23.8 | 112.62 |
| 5.9 | 13.33 | 11.9 | 48.83 | 17.9 | 99.15 | 23.9 | 112.81 |
| 6.0 | 13.62 | 12.0 | 61.66 | 18.0 | 99.43 | 24.0 | 113.00 |

Rainfall data from Environment Canada and Climate Change. Rainfall Frequency Atlas Of Canada for Windsor, N.S. amounts include a 15% increase for climate change.

1:100-Year Design Storm: Cumulative Depth Table



| 1:100-YEAR DESIGN STORM | | | | | | | |
|-------------------------|-----------------------|--------------|-----------------------|--------------|-----------------------|--------------|-----------------------|
| Time (hours) | Cumulative Depth (mm) | Time (hours) | Cumulative Depth (mm) | Time (hours) | Cumulative Depth (mm) | Time (hours) | Cumulative Depth (mm) |
| 0.1 | 0.26 | 6.1 | 19.48 | 12.1 | 97.92 | 18.1 | 147.39 |
| 0.2 | 0.52 | 6.2 | 19.89 | 12.2 | 101.57 | 18.2 | 147.78 |
| 0.3 | 0.79 | 6.3 | 20.30 | 12.3 | 104.32 | 18.3 | 148.17 |
| 0.4 | 1.05 | 6.4 | 20.72 | 12.4 | 106.58 | 18.4 | 148.56 |
| 0.5 | 1.32 | 6.5 | 21.14 | 12.5 | 108.53 | 18.5 | 148.94 |
| 0.6 | 1.59 | 6.6 | 21.57 | 12.6 | 110.26 | 18.6 | 149.32 |
| 0.7 | 1.86 | 6.7 | 22.00 | 12.7 | 111.83 | 18.7 | 149.70 |
| 0.8 | 2.13 | 6.8 | 22.44 | 12.8 | 113.27 | 18.8 | 150.07 |
| 0.9 | 2.40 | 6.9 | 22.88 | 12.9 | 114.60 | 18.9 | 150.44 |
| 1.0 | 2.68 | 7.0 | 23.33 | 13.0 | 115.85 | 19.0 | 150.80 |
| 1.1 | 2.95 | 7.1 | 23.78 | 13.1 | 117.02 | 19.1 | 151.16 |
| 1.2 | 3.23 | 7.2 | 24.24 | 13.2 | 118.13 | 19.2 | 151.52 |
| 1.3 | 3.51 | 7.3 | 24.71 | 13.3 | 119.18 | 19.3 | 151.88 |
| 1.4 | 3.79 | 7.4 | 25.18 | 13.4 | 120.19 | 19.4 | 152.23 |
| 1.5 | 4.07 | 7.5 | 25.65 | 13.5 | 121.15 | 19.5 | 152.58 |
| 1.6 | 4.35 | 7.6 | 26.14 | 13.6 | 122.07 | 19.6 | 152.92 |
| 1.7 | 4.64 | 7.7 | 26.63 | 13.7 | 122.96 | 19.7 | 153.27 |
| 1.8 | 4.93 | 7.8 | 27.13 | 13.8 | 123.82 | 19.8 | 153.61 |
| 1.9 | 5.22 | 7.9 | 27.64 | 13.9 | 124.65 | 19.9 | 153.95 |
| 2.0 | 5.51 | 8.0 | 28.15 | 14.0 | 125.45 | 20.0 | 154.28 |
| 2.1 | 5.80 | 8.1 | 28.67 | 14.1 | 126.23 | 20.1 | 154.62 |
| 2.2 | 6.09 | 8.2 | 29.20 | 14.2 | 126.98 | 20.2 | 154.95 |
| 2.3 | 6.39 | 8.3 | 29.74 | 14.3 | 127.72 | 20.3 | 155.27 |
| 2.4 | 6.69 | 8.4 | 30.29 | 14.4 | 128.43 | 20.4 | 155.60 |
| 2.5 | 6.99 | 8.5 | 30.85 | 14.5 | 129.13 | 20.5 | 155.92 |
| 2.6 | 7.29 | 8.6 | 31.42 | 14.6 | 129.81 | 20.6 | 156.24 |
| 2.7 | 7.60 | 8.7 | 32.00 | 14.7 | 130.47 | 20.7 | 156.56 |
| 2.8 | 7.90 | 8.8 | 32.59 | 14.8 | 131.12 | 20.8 | 156.88 |
| 2.9 | 8.21 | 8.9 | 33.19 | 14.9 | 131.75 | 20.9 | 157.19 |
| 3.0 | 8.52 | 9.0 | 33.81 | 15.0 | 132.37 | 21.0 | 157.50 |
| 3.1 | 8.84 | 9.1 | 34.43 | 15.1 | 132.98 | 21.1 | 157.81 |
| 3.2 | 9.15 | 9.2 | 35.07 | 15.2 | 133.58 | 21.2 | 158.12 |
| 3.3 | 9.47 | 9.3 | 35.73 | 15.3 | 134.16 | 21.3 | 158.43 |
| 3.4 | 9.79 | 9.4 | 36.40 | 15.4 | 134.74 | 21.4 | 158.73 |
| 3.5 | 10.11 | 9.5 | 37.09 | 15.5 | 135.30 | 21.5 | 159.03 |
| 3.6 | 10.43 | 9.6 | 37.80 | 15.6 | 135.85 | 21.6 | 159.33 |
| 3.7 | 10.76 | 9.7 | 38.52 | 15.7 | 136.40 | 21.7 | 159.63 |
| 3.8 | 11.09 | 9.8 | 39.26 | 15.8 | 136.93 | 21.8 | 159.92 |
| 3.9 | 11.42 | 9.9 | 40.03 | 15.9 | 137.46 | 21.9 | 160.22 |
| 4.0 | 11.76 | 10.0 | 40.82 | 16.0 | 137.98 | 22.0 | 160.51 |
| 4.1 | 12.09 | 10.1 | 41.63 | 16.1 | 138.49 | 22.1 | 160.80 |
| 4.2 | 12.43 | 10.2 | 42.48 | 16.2 | 138.99 | 22.2 | 161.09 |
| 4.3 | 12.77 | 10.3 | 43.35 | 16.3 | 139.49 | 22.3 | 161.37 |
| 4.4 | 13.12 | 10.4 | 44.25 | 16.4 | 139.97 | 22.4 | 161.66 |
| 4.5 | 13.47 | 10.5 | 45.20 | 16.5 | 140.46 | 22.5 | 161.94 |
| 4.6 | 13.82 | 10.6 | 46.18 | 16.6 | 140.93 | 22.6 | 162.22 |
| 4.7 | 14.17 | 10.7 | 47.21 | 16.7 | 141.40 | 22.7 | 162.50 |
| 4.8 | 14.53 | 10.8 | 48.29 | 16.8 | 141.86 | 22.8 | 162.78 |
| 4.9 | 14.89 | 10.9 | 49.43 | 16.9 | 142.32 | 22.9 | 163.06 |
| 5.0 | 15.25 | 11.0 | 50.63 | 17.0 | 142.77 | 23.0 | 163.33 |
| 5.1 | 15.62 | 11.1 | 51.92 | 17.1 | 143.21 | 23.1 | 163.61 |
| 5.2 | 15.99 | 11.2 | 53.30 | 17.2 | 143.65 | 23.2 | 163.88 |
| 5.3 | 16.36 | 11.3 | 54.80 | 17.3 | 144.09 | 23.3 | 164.15 |
| 5.4 | 16.74 | 11.4 | 56.45 | 17.4 | 144.52 | 23.4 | 164.42 |
| 5.5 | 17.12 | 11.5 | 58.28 | 17.5 | 144.94 | 23.5 | 164.68 |
| 5.6 | 17.50 | 11.6 | 60.37 | 17.6 | 145.36 | 23.6 | 164.95 |
| 5.7 | 17.89 | 11.7 | 62.85 | 17.7 | 145.77 | 23.7 | 165.21 |
| 5.8 | 18.28 | 11.8 | 65.96 | 17.8 | 146.18 | 23.8 | 165.48 |
| 5.9 | 18.68 | 11.9 | 70.48 | 17.9 | 146.59 | 23.9 | 165.74 |
| 6.0 | 19.08 | 12.0 | 91.63 | 18.0 | 146.99 | 24.0 | 166.00 |

Rainfall data from Environment Canada and Climate Change. Rainfall Frequency Atlas Of Canada for Windsor, N.S. amounts include a 15% increase for climate change.

1:2-Year Winter Design Storm: Cumulative Depth Table



WINTER STORM

1:2-YEAR WINTER DESIGN STORM

| Time (hours) | Cumulative Depth (mm) | Time (hours) | Cumulative Depth (mm) | Time (hours) | Cumulative Depth (mm) | Time (hours) | Cumulative Depth (mm) |
|--------------|-----------------------|--------------|-----------------------|--------------|-----------------------|--------------|-----------------------|
| 0.1 | 0.17 | 6.1 | 12.75 | 12.1 | 54.61 | 18.1 | 83.81 |
| 0.2 | 0.35 | 6.2 | 13.01 | 12.2 | 56.51 | 18.2 | 84.06 |
| 0.3 | 0.53 | 6.3 | 13.28 | 12.3 | 57.99 | 18.3 | 84.31 |
| 0.4 | 0.70 | 6.4 | 13.54 | 12.4 | 59.22 | 18.4 | 84.56 |
| 0.5 | 0.88 | 6.5 | 13.81 | 12.5 | 60.30 | 18.5 | 84.80 |
| 0.6 | 1.06 | 6.6 | 14.08 | 12.6 | 61.27 | 18.6 | 85.05 |
| 0.7 | 1.24 | 6.7 | 14.36 | 12.7 | 62.16 | 18.7 | 85.29 |
| 0.8 | 1.42 | 6.8 | 14.64 | 12.8 | 62.98 | 18.8 | 85.53 |
| 0.9 | 1.60 | 6.9 | 14.92 | 12.9 | 63.74 | 18.9 | 85.77 |
| 1.0 | 1.78 | 7.0 | 15.20 | 13.0 | 64.46 | 19.0 | 86.00 |
| 1.1 | 1.96 | 7.1 | 15.49 | 13.1 | 65.14 | 19.1 | 86.24 |
| 1.2 | 2.15 | 7.2 | 15.78 | 13.2 | 65.79 | 19.2 | 86.47 |
| 1.3 | 2.33 | 7.3 | 16.07 | 13.3 | 66.40 | 19.3 | 86.70 |
| 1.4 | 2.52 | 7.4 | 16.37 | 13.4 | 67.00 | 19.4 | 86.93 |
| 1.5 | 2.71 | 7.5 | 16.67 | 13.5 | 67.56 | 19.5 | 87.16 |
| 1.6 | 2.89 | 7.6 | 16.98 | 13.6 | 68.11 | 19.6 | 87.38 |
| 1.7 | 3.08 | 7.7 | 17.29 | 13.7 | 68.64 | 19.7 | 87.60 |
| 1.8 | 3.27 | 7.8 | 17.60 | 13.8 | 69.15 | 19.8 | 87.83 |
| 1.9 | 3.46 | 7.9 | 17.92 | 13.9 | 69.65 | 19.9 | 88.05 |
| 2.0 | 3.66 | 8.0 | 18.24 | 14.0 | 70.13 | 20.0 | 88.27 |
| 2.1 | 3.85 | 8.1 | 18.57 | 14.1 | 70.60 | 20.1 | 88.48 |
| 2.2 | 4.04 | 8.2 | 18.90 | 14.2 | 71.06 | 20.2 | 88.70 |
| 2.3 | 4.24 | 8.3 | 19.24 | 14.3 | 71.50 | 20.3 | 88.91 |
| 2.4 | 4.44 | 8.4 | 19.58 | 14.4 | 71.94 | 20.4 | 89.13 |
| 2.5 | 4.63 | 8.5 | 19.92 | 14.5 | 72.36 | 20.5 | 89.34 |
| 2.6 | 4.83 | 8.6 | 20.28 | 14.6 | 72.78 | 20.6 | 89.55 |
| 2.7 | 5.03 | 8.7 | 20.64 | 14.7 | 73.18 | 20.7 | 89.76 |
| 2.8 | 5.23 | 8.8 | 21.00 | 14.8 | 73.58 | 20.8 | 89.96 |
| 2.9 | 5.44 | 8.9 | 21.37 | 14.9 | 73.97 | 20.9 | 90.17 |
| 3.0 | 5.64 | 9.0 | 21.75 | 15.0 | 74.35 | 21.0 | 90.37 |
| 3.1 | 5.85 | 9.1 | 22.14 | 15.1 | 74.73 | 21.1 | 90.58 |
| 3.2 | 6.05 | 9.2 | 22.53 | 15.2 | 75.09 | 21.2 | 90.78 |
| 3.3 | 6.26 | 9.3 | 22.93 | 15.3 | 75.46 | 21.3 | 90.98 |
| 3.4 | 6.47 | 9.4 | 23.34 | 15.4 | 75.81 | 21.4 | 91.18 |
| 3.5 | 6.68 | 9.5 | 23.76 | 15.5 | 76.16 | 21.5 | 91.38 |
| 3.6 | 6.89 | 9.6 | 24.19 | 15.6 | 76.51 | 21.6 | 91.58 |
| 3.7 | 7.11 | 9.7 | 24.63 | 15.7 | 76.85 | 21.7 | 91.77 |
| 3.8 | 7.32 | 9.8 | 25.08 | 15.8 | 77.18 | 21.8 | 91.97 |
| 3.9 | 7.54 | 9.9 | 25.55 | 15.9 | 77.51 | 21.9 | 92.16 |
| 4.0 | 7.76 | 10.0 | 26.02 | 16.0 | 77.83 | 22.0 | 92.35 |
| 4.1 | 7.98 | 10.1 | 26.51 | 16.1 | 78.15 | 22.1 | 92.54 |
| 4.2 | 8.20 | 10.2 | 27.01 | 16.2 | 78.47 | 22.2 | 92.74 |
| 4.3 | 8.42 | 10.3 | 27.53 | 16.3 | 78.78 | 22.3 | 92.92 |
| 4.4 | 8.64 | 10.4 | 28.07 | 16.4 | 79.09 | 22.4 | 93.11 |
| 4.5 | 8.87 | 10.5 | 28.63 | 16.5 | 79.39 | 22.5 | 93.30 |
| 4.6 | 9.10 | 10.6 | 29.21 | 16.6 | 79.69 | 22.6 | 93.49 |
| 4.7 | 9.33 | 10.7 | 29.81 | 16.7 | 79.99 | 22.7 | 93.67 |
| 4.8 | 9.56 | 10.8 | 30.45 | 16.8 | 80.28 | 22.8 | 93.86 |
| 4.9 | 9.79 | 10.9 | 31.11 | 16.9 | 80.57 | 22.9 | 94.04 |
| 5.0 | 10.03 | 11.0 | 31.81 | 17.0 | 80.85 | 23.0 | 94.22 |
| 5.1 | 10.26 | 11.1 | 32.55 | 17.1 | 81.14 | 23.1 | 94.41 |
| 5.2 | 10.50 | 11.2 | 33.34 | 17.2 | 81.42 | 23.2 | 94.59 |
| 5.3 | 10.74 | 11.3 | 34.19 | 17.3 | 81.69 | 23.3 | 94.77 |
| 5.4 | 10.99 | 11.4 | 35.11 | 17.4 | 81.97 | 23.4 | 94.94 |
| 5.5 | 11.23 | 11.5 | 36.13 | 17.5 | 82.24 | 23.5 | 95.12 |
| 5.6 | 11.48 | 11.6 | 37.28 | 17.6 | 82.51 | 23.6 | 95.30 |
| 5.7 | 11.73 | 11.7 | 38.62 | 17.7 | 82.77 | 23.7 | 95.48 |
| 5.8 | 11.98 | 11.8 | 40.28 | 17.8 | 83.03 | 23.8 | 95.65 |
| 5.9 | 12.23 | 11.9 | 42.59 | 17.9 | 83.29 | 23.9 | 95.83 |
| 6.0 | 12.49 | 12.0 | 51.49 | 18.0 | 83.55 | 24.0 | 96.00 |

Rainfall data from Environment Canada and Climate Change. Rainfall Frequency Atlas Of Canada for Windsor, N.S. amounts include an additional 1.5mm/hr of snow melt and a 15% increase for climate change.

1:5-Year Winter Design Storm: Cumulative Depth Table



WINTER STORM

1:5-YEAR WINTER DESIGN STORM

| Time (hours) | Cumulative Depth (mm) | Time (hours) | Cumulative Depth (mm) | Time (hours) | Cumulative Depth (mm) | Time (hours) | Cumulative Depth (mm) |
|--------------|-----------------------|--------------|-----------------------|--------------|-----------------------|--------------|-----------------------|
| 0.1 | 0.18 | 6.1 | 13.23 | 12.1 | 60.65 | 18.1 | 92.36 |
| 0.2 | 0.36 | 6.2 | 13.50 | 12.2 | 62.83 | 18.2 | 92.62 |
| 0.3 | 0.54 | 6.3 | 13.78 | 12.3 | 64.51 | 18.3 | 92.88 |
| 0.4 | 0.72 | 6.4 | 14.06 | 12.4 | 65.90 | 18.4 | 93.14 |
| 0.5 | 0.90 | 6.5 | 14.34 | 12.5 | 67.10 | 18.5 | 93.40 |
| 0.6 | 1.09 | 6.6 | 14.62 | 12.6 | 68.18 | 18.6 | 93.66 |
| 0.7 | 1.27 | 6.7 | 14.91 | 12.7 | 69.16 | 18.7 | 93.91 |
| 0.8 | 1.46 | 6.8 | 15.21 | 12.8 | 70.07 | 18.8 | 94.16 |
| 0.9 | 1.65 | 6.9 | 15.50 | 12.9 | 70.91 | 18.9 | 94.41 |
| 1.0 | 1.83 | 7.0 | 15.80 | 13.0 | 71.70 | 19.0 | 94.65 |
| 1.1 | 2.02 | 7.1 | 16.10 | 13.1 | 72.44 | 19.1 | 94.90 |
| 1.2 | 2.21 | 7.2 | 16.41 | 13.2 | 73.15 | 19.2 | 95.14 |
| 1.3 | 2.40 | 7.3 | 16.72 | 13.3 | 73.82 | 19.3 | 95.38 |
| 1.4 | 2.59 | 7.4 | 17.03 | 13.4 | 74.47 | 19.4 | 95.62 |
| 1.5 | 2.79 | 7.5 | 17.35 | 13.5 | 75.08 | 19.5 | 95.85 |
| 1.6 | 2.98 | 7.6 | 17.67 | 13.6 | 75.68 | 19.6 | 96.09 |
| 1.7 | 3.18 | 7.7 | 18.00 | 13.7 | 76.25 | 19.7 | 96.32 |
| 1.8 | 3.37 | 7.8 | 18.33 | 13.8 | 76.80 | 19.8 | 96.55 |
| 1.9 | 3.57 | 7.9 | 18.67 | 13.9 | 77.34 | 19.9 | 96.78 |
| 2.0 | 3.77 | 8.0 | 19.01 | 14.0 | 77.86 | 20.0 | 97.01 |
| 2.1 | 3.97 | 8.1 | 19.35 | 14.1 | 78.36 | 20.1 | 97.23 |
| 2.2 | 4.17 | 8.2 | 19.70 | 14.2 | 78.85 | 20.2 | 97.46 |
| 2.3 | 4.37 | 8.3 | 20.06 | 14.3 | 79.33 | 20.3 | 97.68 |
| 2.4 | 4.57 | 8.4 | 20.42 | 14.4 | 79.80 | 20.4 | 97.90 |
| 2.5 | 4.78 | 8.5 | 20.79 | 14.5 | 80.25 | 20.5 | 98.12 |
| 2.6 | 4.99 | 8.6 | 21.17 | 14.6 | 80.70 | 20.6 | 98.34 |
| 2.7 | 5.19 | 8.7 | 21.55 | 14.7 | 81.13 | 20.7 | 98.55 |
| 2.8 | 5.40 | 8.8 | 21.94 | 14.8 | 81.55 | 20.8 | 98.77 |
| 2.9 | 5.61 | 8.9 | 22.33 | 14.9 | 81.97 | 20.9 | 98.98 |
| 3.0 | 5.82 | 9.0 | 22.74 | 15.0 | 82.38 | 21.0 | 99.19 |
| 3.1 | 6.04 | 9.1 | 23.15 | 15.1 | 82.78 | 21.1 | 99.40 |
| 3.2 | 6.25 | 9.2 | 23.57 | 15.2 | 83.17 | 21.2 | 99.61 |
| 3.3 | 6.46 | 9.3 | 24.00 | 15.3 | 83.55 | 21.3 | 99.82 |
| 3.4 | 6.68 | 9.4 | 24.44 | 15.4 | 83.93 | 21.4 | 100.03 |
| 3.5 | 6.90 | 9.5 | 24.89 | 15.5 | 84.30 | 21.5 | 100.23 |
| 3.6 | 7.12 | 9.6 | 25.35 | 15.6 | 84.67 | 21.6 | 100.44 |
| 3.7 | 7.34 | 9.7 | 25.82 | 15.7 | 85.03 | 21.7 | 100.64 |
| 3.8 | 7.57 | 9.8 | 26.30 | 15.8 | 85.38 | 21.8 | 100.84 |
| 3.9 | 7.79 | 9.9 | 26.80 | 15.9 | 85.73 | 21.9 | 101.04 |
| 4.0 | 8.02 | 10.0 | 27.31 | 16.0 | 86.08 | 22.0 | 101.24 |
| 4.1 | 8.25 | 10.1 | 27.84 | 16.1 | 86.41 | 22.1 | 101.44 |
| 4.2 | 8.47 | 10.2 | 28.38 | 16.2 | 86.75 | 22.2 | 101.64 |
| 4.3 | 8.71 | 10.3 | 28.94 | 16.3 | 87.08 | 22.3 | 101.83 |
| 4.4 | 8.94 | 10.4 | 29.53 | 16.4 | 87.40 | 22.4 | 102.03 |
| 4.5 | 9.18 | 10.5 | 30.13 | 16.5 | 87.72 | 22.5 | 102.22 |
| 4.6 | 9.41 | 10.6 | 30.76 | 16.6 | 88.04 | 22.6 | 102.41 |
| 4.7 | 9.65 | 10.7 | 31.42 | 16.7 | 88.35 | 22.7 | 102.60 |
| 4.8 | 9.89 | 10.8 | 32.11 | 16.8 | 88.66 | 22.8 | 102.79 |
| 4.9 | 10.14 | 10.9 | 32.84 | 16.9 | 88.96 | 22.9 | 102.98 |
| 5.0 | 10.38 | 11.0 | 33.60 | 17.0 | 89.26 | 23.0 | 103.17 |
| 5.1 | 10.63 | 11.1 | 34.42 | 17.1 | 89.56 | 23.1 | 103.36 |
| 5.2 | 10.88 | 11.2 | 35.29 | 17.2 | 89.85 | 23.2 | 103.54 |
| 5.3 | 11.13 | 11.3 | 36.23 | 17.3 | 90.14 | 23.3 | 103.73 |
| 5.4 | 11.38 | 11.4 | 37.25 | 17.4 | 90.43 | 23.4 | 103.91 |
| 5.5 | 11.64 | 11.5 | 38.39 | 17.5 | 90.71 | 23.5 | 104.10 |
| 5.6 | 11.90 | 11.6 | 39.68 | 17.6 | 90.99 | 23.6 | 104.28 |
| 5.7 | 12.16 | 11.7 | 41.20 | 17.7 | 91.27 | 23.7 | 104.46 |
| 5.8 | 12.42 | 11.8 | 43.08 | 17.8 | 91.55 | 23.8 | 104.64 |
| 5.9 | 12.69 | 11.9 | 45.76 | 17.9 | 91.82 | 23.9 | 104.82 |
| 6.0 | 12.96 | 12.0 | 56.98 | 18.0 | 92.09 | 24.0 | 105.00 |

Rainfall data from Environment Canada and Climate Change. Rainfall Frequency Atlas Of Canada for Windsor, N.S. amounts include an additional 1.5mm/hr of snow melt and a 15% increase for climate change.

1:10-Year Winter Design Storm: Cumulative Depth Table



WINTER STORM

1:10-YEAR WINTER DESIGN STORM

| Time (hours) | Cumulative Depth (mm) | Time (hours) | Cumulative Depth (mm) | Time (hours) | Cumulative Depth (mm) | Time (hours) | Cumulative Depth (mm) |
|--------------|-----------------------|--------------|-----------------------|--------------|-----------------------|--------------|-----------------------|
| 0.1 | 0.19 | 6.1 | 13.78 | 12.1 | 65.14 | 18.1 | 98.83 |
| 0.2 | 0.37 | 6.2 | 14.07 | 12.2 | 67.52 | 18.2 | 99.11 |
| 0.3 | 0.56 | 6.3 | 14.36 | 12.3 | 69.33 | 18.3 | 99.38 |
| 0.4 | 0.75 | 6.4 | 14.65 | 12.4 | 70.83 | 18.4 | 99.65 |
| 0.5 | 0.94 | 6.5 | 14.94 | 12.5 | 72.13 | 18.5 | 99.92 |
| 0.6 | 1.13 | 6.6 | 15.24 | 12.6 | 73.28 | 18.6 | 100.19 |
| 0.7 | 1.32 | 6.7 | 15.54 | 12.7 | 74.33 | 18.7 | 100.45 |
| 0.8 | 1.52 | 6.8 | 15.85 | 12.8 | 75.30 | 18.8 | 100.71 |
| 0.9 | 1.71 | 6.9 | 16.16 | 12.9 | 76.20 | 18.9 | 100.97 |
| 1.0 | 1.90 | 7.0 | 16.47 | 13.0 | 77.04 | 19.0 | 101.23 |
| 1.1 | 2.10 | 7.1 | 16.79 | 13.1 | 77.84 | 19.1 | 101.48 |
| 1.2 | 2.30 | 7.2 | 17.11 | 13.2 | 78.59 | 19.2 | 101.74 |
| 1.3 | 2.50 | 7.3 | 17.44 | 13.3 | 79.30 | 19.3 | 101.99 |
| 1.4 | 2.69 | 7.4 | 17.77 | 13.4 | 79.99 | 19.4 | 102.24 |
| 1.5 | 2.90 | 7.5 | 18.10 | 13.5 | 80.64 | 19.5 | 102.48 |
| 1.6 | 3.10 | 7.6 | 18.44 | 13.6 | 81.27 | 19.6 | 102.73 |
| 1.7 | 3.30 | 7.7 | 18.78 | 13.7 | 81.88 | 19.7 | 102.97 |
| 1.8 | 3.50 | 7.8 | 19.13 | 13.8 | 82.47 | 19.8 | 103.21 |
| 1.9 | 3.71 | 7.9 | 19.48 | 13.9 | 83.04 | 19.9 | 103.45 |
| 2.0 | 3.92 | 8.0 | 19.84 | 14.0 | 83.59 | 20.0 | 103.69 |
| 2.1 | 4.12 | 8.1 | 20.20 | 14.1 | 84.12 | 20.1 | 103.92 |
| 2.2 | 4.33 | 8.2 | 20.57 | 14.2 | 84.64 | 20.2 | 104.16 |
| 2.3 | 4.54 | 8.3 | 20.95 | 14.3 | 85.14 | 20.3 | 104.39 |
| 2.4 | 4.75 | 8.4 | 21.33 | 14.4 | 85.64 | 20.4 | 104.62 |
| 2.5 | 4.97 | 8.5 | 21.72 | 14.5 | 86.12 | 20.5 | 104.85 |
| 2.6 | 5.18 | 8.6 | 22.11 | 14.6 | 86.58 | 20.6 | 105.07 |
| 2.7 | 5.40 | 8.7 | 22.51 | 14.7 | 87.04 | 20.7 | 105.30 |
| 2.8 | 5.61 | 8.8 | 22.92 | 14.8 | 87.49 | 20.8 | 105.52 |
| 2.9 | 5.83 | 8.9 | 23.34 | 14.9 | 87.93 | 20.9 | 105.74 |
| 3.0 | 6.05 | 9.0 | 23.76 | 15.0 | 88.36 | 21.0 | 105.96 |
| 3.1 | 6.27 | 9.1 | 24.20 | 15.1 | 88.78 | 21.1 | 106.18 |
| 3.2 | 6.50 | 9.2 | 24.64 | 15.2 | 89.19 | 21.2 | 106.40 |
| 3.3 | 6.72 | 9.3 | 25.09 | 15.3 | 89.60 | 21.3 | 106.62 |
| 3.4 | 6.95 | 9.4 | 25.56 | 15.4 | 90.00 | 21.4 | 106.83 |
| 3.5 | 7.18 | 9.5 | 26.03 | 15.5 | 90.39 | 21.5 | 107.05 |
| 3.6 | 7.40 | 9.6 | 26.52 | 15.6 | 90.77 | 21.6 | 107.26 |
| 3.7 | 7.64 | 9.7 | 27.01 | 15.7 | 91.15 | 21.7 | 107.47 |
| 3.8 | 7.87 | 9.8 | 27.53 | 15.8 | 91.52 | 21.8 | 107.68 |
| 3.9 | 8.10 | 9.9 | 28.05 | 15.9 | 91.89 | 21.9 | 107.89 |
| 4.0 | 8.34 | 10.0 | 28.59 | 16.0 | 92.25 | 22.0 | 108.10 |
| 4.1 | 8.58 | 10.1 | 29.15 | 16.1 | 92.60 | 22.1 | 108.30 |
| 4.2 | 8.82 | 10.2 | 29.73 | 16.2 | 92.95 | 22.2 | 108.51 |
| 4.3 | 9.06 | 10.3 | 30.33 | 16.3 | 93.30 | 22.3 | 108.71 |
| 4.4 | 9.30 | 10.4 | 30.95 | 16.4 | 93.64 | 22.4 | 108.91 |
| 4.5 | 9.55 | 10.5 | 31.59 | 16.5 | 93.98 | 22.5 | 109.11 |
| 4.6 | 9.79 | 10.6 | 32.26 | 16.6 | 94.31 | 22.6 | 109.31 |
| 4.7 | 10.04 | 10.7 | 32.96 | 16.7 | 94.63 | 22.7 | 109.51 |
| 4.8 | 10.30 | 10.8 | 33.69 | 16.8 | 94.96 | 22.8 | 109.71 |
| 4.9 | 10.55 | 10.9 | 34.46 | 16.9 | 95.28 | 22.9 | 109.91 |
| 5.0 | 10.81 | 11.0 | 35.28 | 17.0 | 95.59 | 23.0 | 110.10 |
| 5.1 | 11.06 | 11.1 | 36.15 | 17.1 | 95.90 | 23.1 | 110.30 |
| 5.2 | 11.32 | 11.2 | 37.08 | 17.2 | 96.21 | 23.2 | 110.49 |
| 5.3 | 11.59 | 11.3 | 38.09 | 17.3 | 96.51 | 23.3 | 110.68 |
| 5.4 | 11.85 | 11.4 | 39.19 | 17.4 | 96.81 | 23.4 | 110.87 |
| 5.5 | 12.12 | 11.5 | 40.41 | 17.5 | 97.11 | 23.5 | 111.06 |
| 5.6 | 12.39 | 11.6 | 41.80 | 17.6 | 97.41 | 23.6 | 111.25 |
| 5.7 | 12.66 | 11.7 | 43.43 | 17.7 | 97.70 | 23.7 | 111.44 |
| 5.8 | 12.94 | 11.8 | 45.48 | 17.8 | 97.99 | 23.8 | 111.63 |
| 5.9 | 13.21 | 11.9 | 48.40 | 17.9 | 98.27 | 23.9 | 111.81 |
| 6.0 | 13.50 | 12.0 | 61.11 | 18.0 | 98.55 | 24.0 | 112.00 |

Rainfall data from Environment Canada and Climate Change. Rainfall Frequency Atlas Of Canada for Windsor, N.S. amounts include an additional 1.5mm/hr of snow melt and a 15% increase for climate change.

1:100-Year Winter Design Storm: Cumulative Depth Table



WINTER STORM

1:100-YEAR WINTER DESIGN STORM

| Time (hours) | Cumulative Depth (mm) | Time (hours) | Cumulative Depth (mm) | Time (hours) | Cumulative Depth (mm) | Time (hours) | Cumulative Depth (mm) |
|--------------|-----------------------|--------------|-----------------------|--------------|-----------------------|--------------|-----------------------|
| 0.1 | 0.21 | 6.1 | 15.84 | 12.1 | 79.63 | 18.1 | 119.87 |
| 0.2 | 0.43 | 6.2 | 16.18 | 12.2 | 82.60 | 18.2 | 120.19 |
| 0.3 | 0.64 | 6.3 | 16.51 | 12.3 | 84.84 | 18.3 | 120.50 |
| 0.4 | 0.86 | 6.4 | 16.85 | 12.4 | 86.68 | 18.4 | 120.82 |
| 0.5 | 1.07 | 6.5 | 17.19 | 12.5 | 88.26 | 18.5 | 121.13 |
| 0.6 | 1.29 | 6.6 | 17.54 | 12.6 | 89.67 | 18.6 | 121.44 |
| 0.7 | 1.51 | 6.7 | 17.89 | 12.7 | 90.95 | 18.7 | 121.74 |
| 0.8 | 1.73 | 6.8 | 18.25 | 12.8 | 92.12 | 18.8 | 122.04 |
| 0.9 | 1.95 | 6.9 | 18.61 | 12.9 | 93.20 | 18.9 | 122.34 |
| 1.0 | 2.18 | 7.0 | 18.97 | 13.0 | 94.21 | 19.0 | 122.64 |
| 1.1 | 2.40 | 7.1 | 19.34 | 13.1 | 95.17 | 19.1 | 122.93 |
| 1.2 | 2.63 | 7.2 | 19.71 | 13.2 | 96.07 | 19.2 | 123.22 |
| 1.3 | 2.85 | 7.3 | 20.09 | 13.3 | 96.93 | 19.3 | 123.51 |
| 1.4 | 3.08 | 7.4 | 20.48 | 13.4 | 97.74 | 19.4 | 123.80 |
| 1.5 | 3.31 | 7.5 | 20.86 | 13.5 | 98.53 | 19.5 | 124.08 |
| 1.6 | 3.54 | 7.6 | 21.26 | 13.6 | 99.28 | 19.6 | 124.37 |
| 1.7 | 3.77 | 7.7 | 21.66 | 13.7 | 100.00 | 19.7 | 124.65 |
| 1.8 | 4.01 | 7.8 | 22.06 | 13.8 | 100.70 | 19.8 | 124.92 |
| 1.9 | 4.24 | 7.9 | 22.48 | 13.9 | 101.37 | 19.9 | 125.20 |
| 2.0 | 4.48 | 8.0 | 22.89 | 14.0 | 102.02 | 20.0 | 125.47 |
| 2.1 | 4.72 | 8.1 | 23.32 | 14.1 | 102.65 | 20.1 | 125.74 |
| 2.2 | 4.96 | 8.2 | 23.75 | 14.2 | 103.27 | 20.2 | 126.01 |
| 2.3 | 5.20 | 8.3 | 24.19 | 14.3 | 103.86 | 20.3 | 126.28 |
| 2.4 | 5.44 | 8.4 | 24.64 | 14.4 | 104.45 | 20.4 | 126.54 |
| 2.5 | 5.68 | 8.5 | 25.09 | 14.5 | 105.01 | 20.5 | 126.80 |
| 2.6 | 5.93 | 8.6 | 25.55 | 14.6 | 105.57 | 20.6 | 127.07 |
| 2.7 | 6.18 | 8.7 | 26.02 | 14.7 | 106.10 | 20.7 | 127.32 |
| 2.8 | 6.43 | 8.8 | 26.50 | 14.8 | 106.63 | 20.8 | 127.58 |
| 2.9 | 6.68 | 8.9 | 26.99 | 14.9 | 107.15 | 20.9 | 127.84 |
| 3.0 | 6.93 | 9.0 | 27.49 | 15.0 | 107.65 | 21.0 | 128.09 |
| 3.1 | 7.19 | 9.1 | 28.00 | 15.1 | 108.15 | 21.1 | 128.34 |
| 3.2 | 7.44 | 9.2 | 28.52 | 15.2 | 108.63 | 21.2 | 128.59 |
| 3.3 | 7.70 | 9.3 | 29.06 | 15.3 | 109.11 | 21.3 | 128.84 |
| 3.4 | 7.96 | 9.4 | 29.60 | 15.4 | 109.57 | 21.4 | 129.09 |
| 3.5 | 8.22 | 9.5 | 30.16 | 15.5 | 110.03 | 21.5 | 129.33 |
| 3.6 | 8.48 | 9.6 | 30.74 | 15.6 | 110.48 | 21.6 | 129.58 |
| 3.7 | 8.75 | 9.7 | 31.33 | 15.7 | 110.93 | 21.7 | 129.82 |
| 3.8 | 9.02 | 9.8 | 31.93 | 15.8 | 111.36 | 21.8 | 130.06 |
| 3.9 | 9.29 | 9.9 | 32.55 | 15.9 | 111.79 | 21.9 | 130.30 |
| 4.0 | 9.56 | 10.0 | 33.20 | 16.0 | 112.21 | 22.0 | 130.53 |
| 4.1 | 9.83 | 10.1 | 33.86 | 16.1 | 112.63 | 22.1 | 130.77 |
| 4.2 | 10.11 | 10.2 | 34.54 | 16.2 | 113.03 | 22.2 | 131.00 |
| 4.3 | 10.39 | 10.3 | 35.25 | 16.3 | 113.44 | 22.3 | 131.24 |
| 4.4 | 10.67 | 10.4 | 35.99 | 16.4 | 113.83 | 22.4 | 131.47 |
| 4.5 | 10.95 | 10.5 | 36.76 | 16.5 | 114.23 | 22.5 | 131.70 |
| 4.6 | 11.24 | 10.6 | 37.56 | 16.6 | 114.61 | 22.6 | 131.93 |
| 4.7 | 11.53 | 10.7 | 38.39 | 16.7 | 114.99 | 22.7 | 132.16 |
| 4.8 | 11.82 | 10.8 | 39.27 | 16.8 | 115.37 | 22.8 | 132.38 |
| 4.9 | 12.11 | 10.9 | 40.20 | 16.9 | 115.74 | 22.9 | 132.61 |
| 5.0 | 12.40 | 11.0 | 41.18 | 17.0 | 116.11 | 23.0 | 132.83 |
| 5.1 | 12.70 | 11.1 | 42.23 | 17.1 | 116.47 | 23.1 | 133.05 |
| 5.2 | 13.00 | 11.2 | 43.35 | 17.2 | 116.83 | 23.2 | 133.27 |
| 5.3 | 13.31 | 11.3 | 44.57 | 17.3 | 117.18 | 23.3 | 133.49 |
| 5.4 | 13.61 | 11.4 | 45.91 | 17.4 | 117.53 | 23.4 | 133.71 |
| 5.5 | 13.92 | 11.5 | 47.40 | 17.5 | 117.87 | 23.5 | 133.93 |
| 5.6 | 14.23 | 11.6 | 49.10 | 17.6 | 118.21 | 23.6 | 134.15 |
| 5.7 | 14.55 | 11.7 | 51.11 | 17.7 | 118.55 | 23.7 | 134.36 |
| 5.8 | 14.87 | 11.8 | 53.65 | 17.8 | 118.89 | 23.8 | 134.58 |
| 5.9 | 15.19 | 11.9 | 57.32 | 17.9 | 119.22 | 23.9 | 134.79 |
| 6.0 | 15.52 | 12.0 | 74.51 | 18.0 | 119.54 | 24.0 | 135.00 |

Rainfall data from Environment Canada and Climate Change. Rainfall Frequency Atlas Of Canada for Windsor, N.S. amounts include an additional 1.5mm/hr of snow melt and a 15% increase for climate change.

APPENDIX F – STANDARD DETAILS

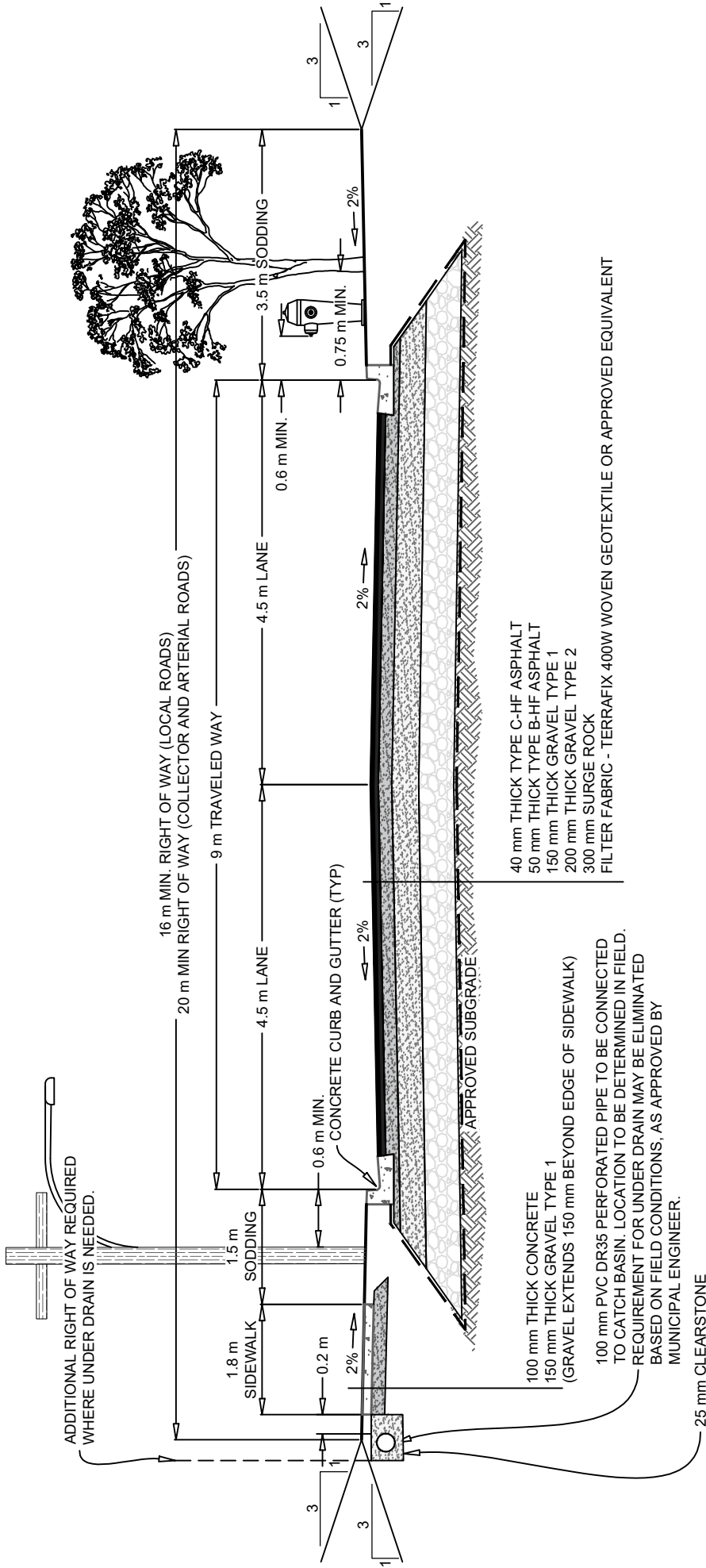

ADDITIONAL RIGHT OF WAY REQUIRED WHERE UNDER DRAIN IS NEEDED.

- 100 mm THICK CONCRETE
- 150 mm THICK GRAVEL TYPE 1 (GRAVEL EXTENDS 150 mm BEYOND EDGE OF SIDEWALK)
- 100 mm PVC DR35 PERFORATED PIPE TO BE CONNECTED TO CATCH BASIN. LOCATION TO BE DETERMINED IN FIELD. REQUIREMENT FOR UNDER DRAIN MAY BE ELIMINATED BASED ON FIELD CONDITIONS, AS APPROVED BY MUNICIPAL ENGINEER.
- 25 mm CLEARSTONE

- 40 mm THICK TYPE C-HF ASPHALT
- 50 mm THICK TYPE B-HF ASPHALT
- 150 mm THICK GRAVEL TYPE 1
- 200 mm THICK GRAVEL TYPE 2
- 300 mm SURGE ROCK
- FILTER FABRIC - TERRAFIX 400W WOVEN GEOTEXTILE OR APPROVED EQUIVALENT

SUBGRADE TO BE REVIEWED AND CONFIRMED BY GEOTECHNICAL ENGINEER.



| | |
|---|--------------------|
| WEST HANTS REGIONAL MUNICIPALITY | |
| STANDARD DETAIL | |
| URBAN LOCAL ROAD CROSS SECTION - FULLY SERVICED | |
| DATE | September 27, 2022 |
| DRAWING NO. | WH-01 |
| SCALE | APPROVED |
| | N.T.S. |

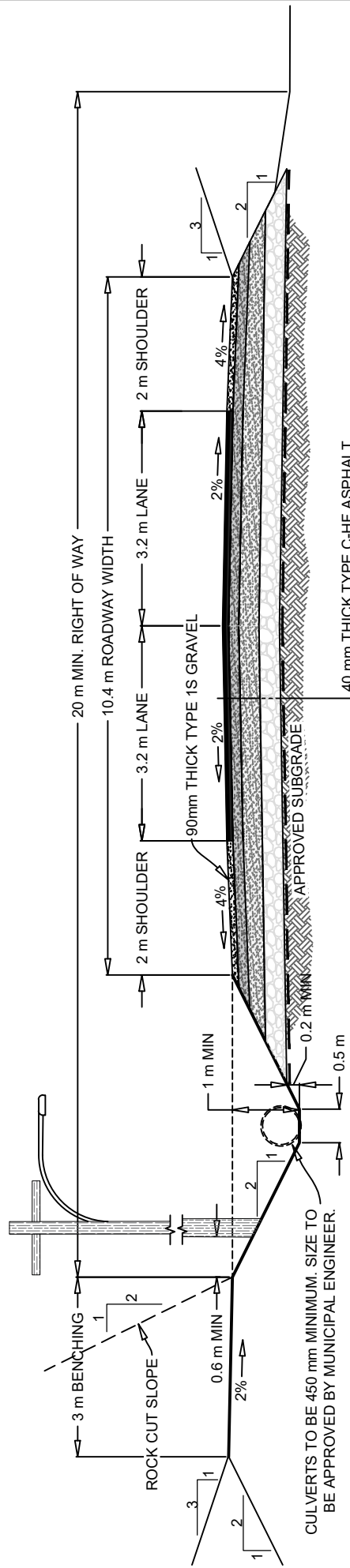

- 40 mm THICK TYPE C-HF ASPHALT
- 50 mm THICK TYPE B-HF ASPHALT
- 150 mm THICK GRAVEL TYPE 1
- 200 mm THICK GRAVEL TYPE 2
- 300 mm SURGE ROCK
- FILTER FABRIC - TERRAFIX 400W WOVEN GEOTEXTILE OR APPROVED EQUIVALENT

SUBGRADE TO BE REVIEWED AND CONFIRMED BY GEOTECHNICAL ENGINEER.



WEST HANTS REGIONAL MUNICIPALITY
STANDARD DETAIL

| | |
|--|--------------------|
| RURAL LOCAL ROAD CROSS SECTION - WITHOUT STORM SEWER | |
| DATE | September 27, 2022 |
| DRAWING NO. | WH-02 |
| SCALE | APPROVED |
| | N.T.S. |

CURB AND GUTTER

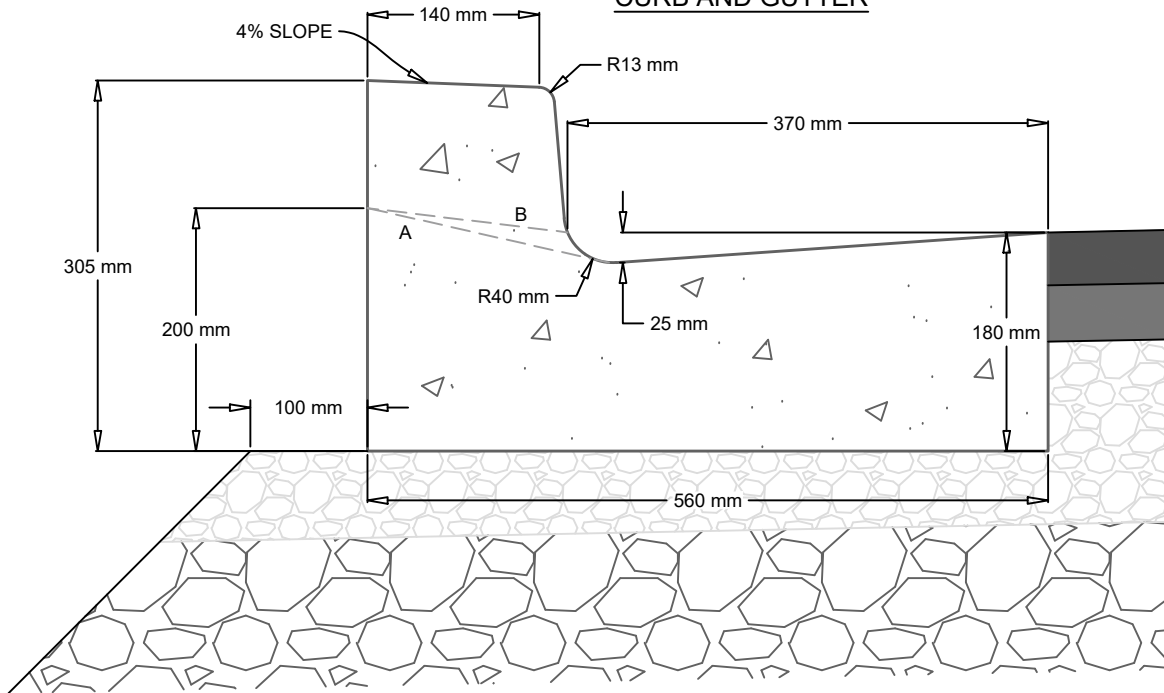

NOTES:
 LINE A INDICATES CURB AT PEDESTRIAN RAMPS.
 LINE B INDICATES CURB AT DRIVEWAYS

MOUNTABLE CURB AND GUTTER

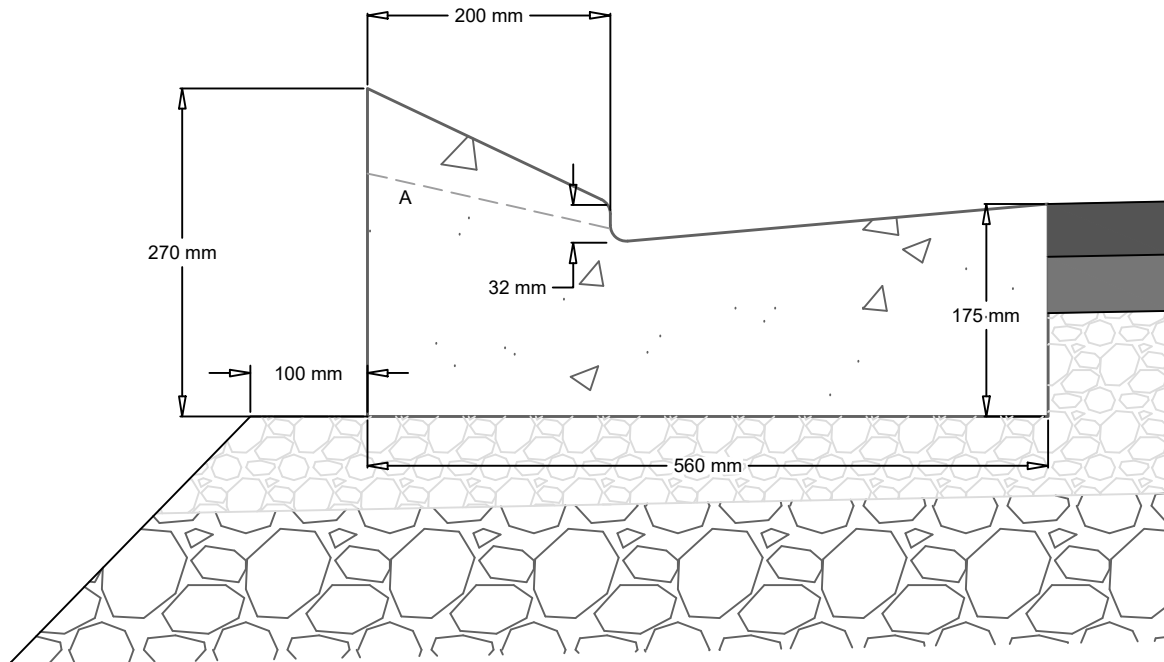

WEST HANTS REGIONAL MUNICIPALITY

STANDARD DETAIL

CONCRETE CURB

| | | | |
|-------------|--------------------|----------|--------|
| DATE | September 27, 2022 | SCALE | N.T.S. |
| DRAWING NO. | WH-03 | APPROVED | |

URBAN ROAD CUL-DE-SAC

FULLY SERVICED

ROAD RESERVE
(AS REQUIRED)

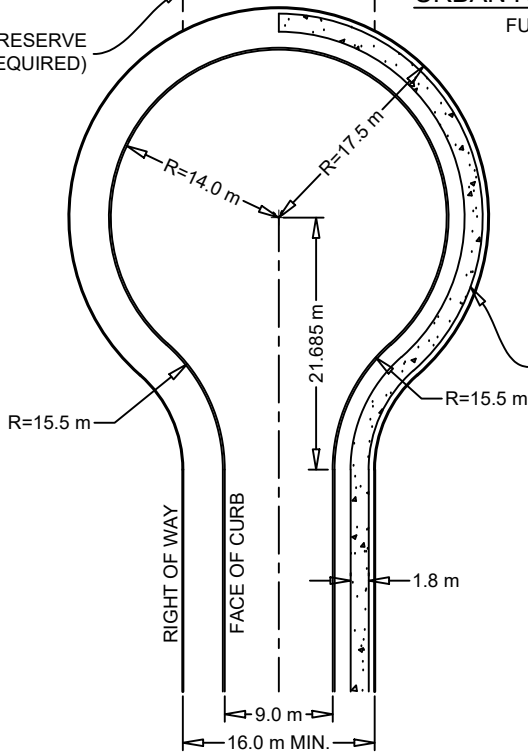

SYMMETRICAL BULB

ROAD RESERVE
(AS REQUIRED)

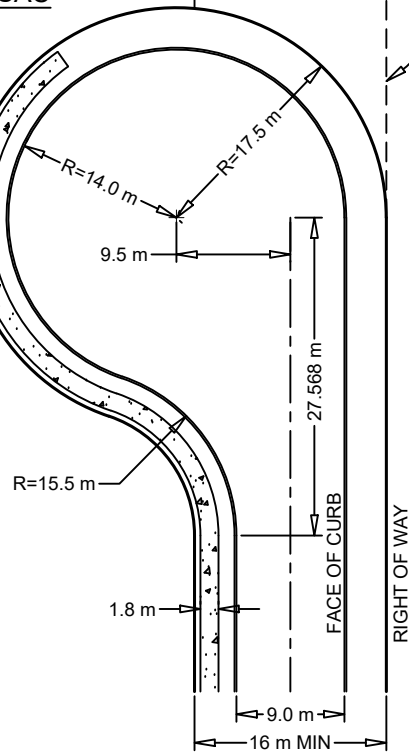

OFFSET BULB

RURAL CUL-DE-SAC

WITHOUT STORM SEWERS

ROAD RESERVE
(AS REQUIRED)

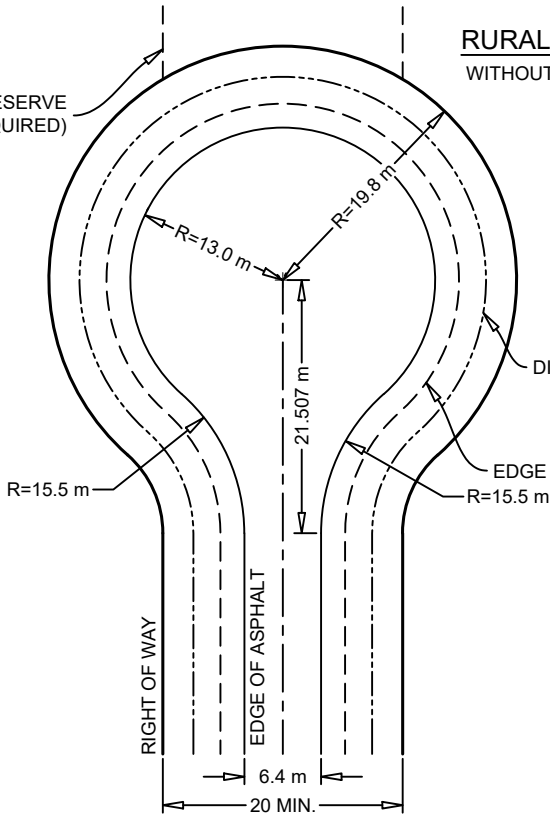

SYMMETRICAL BULB

ROAD RESERVE
(AS REQUIRED)

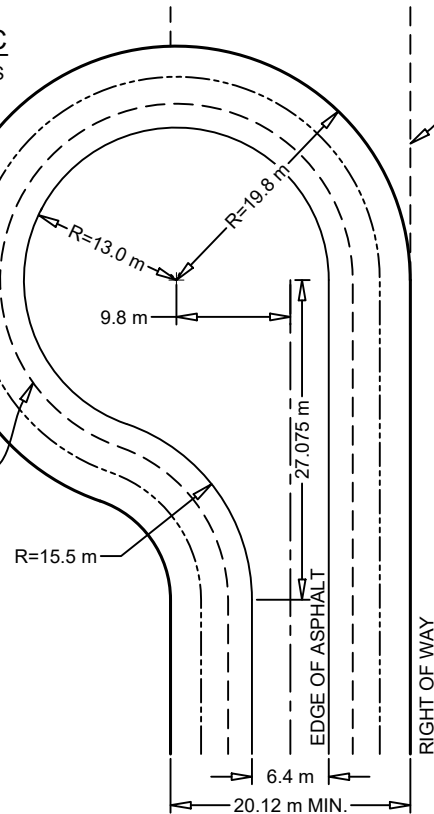

OFFSET BULB



WEST HANTS REGIONAL MUNICIPALITY

STANDARD DETAIL

TYPICAL CUL-DE-SAC BULB

| | | | |
|-------------|------------------|----------|--------|
| DATE | October 24, 2023 | SCALE | N.T.S. |
| DRAWING NO. | WH-04 | APPROVED | |

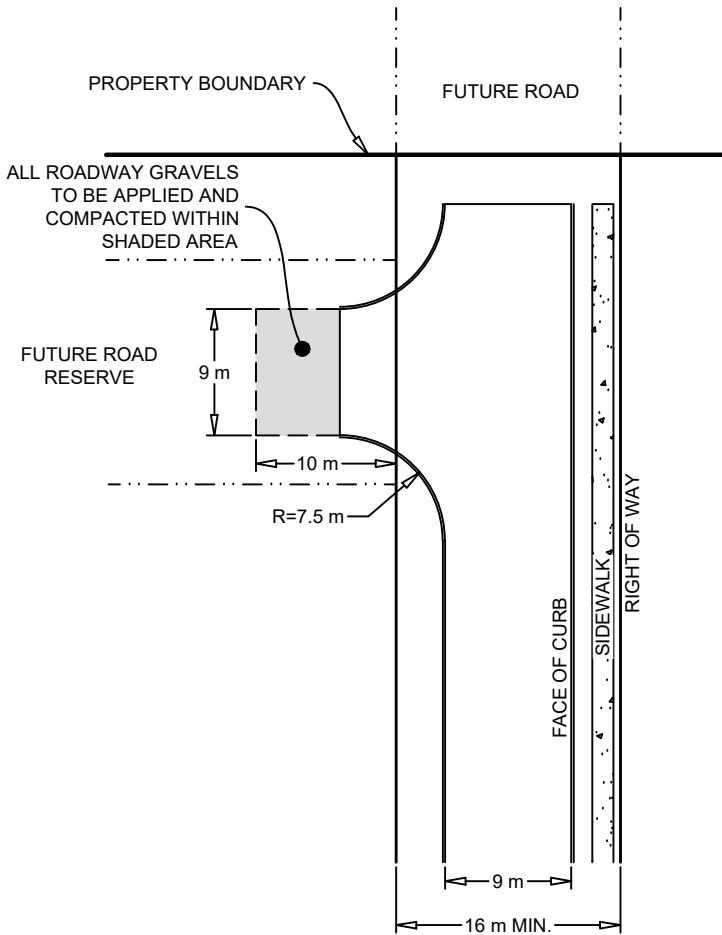

URBAN ROAD
FULLY SERVICED

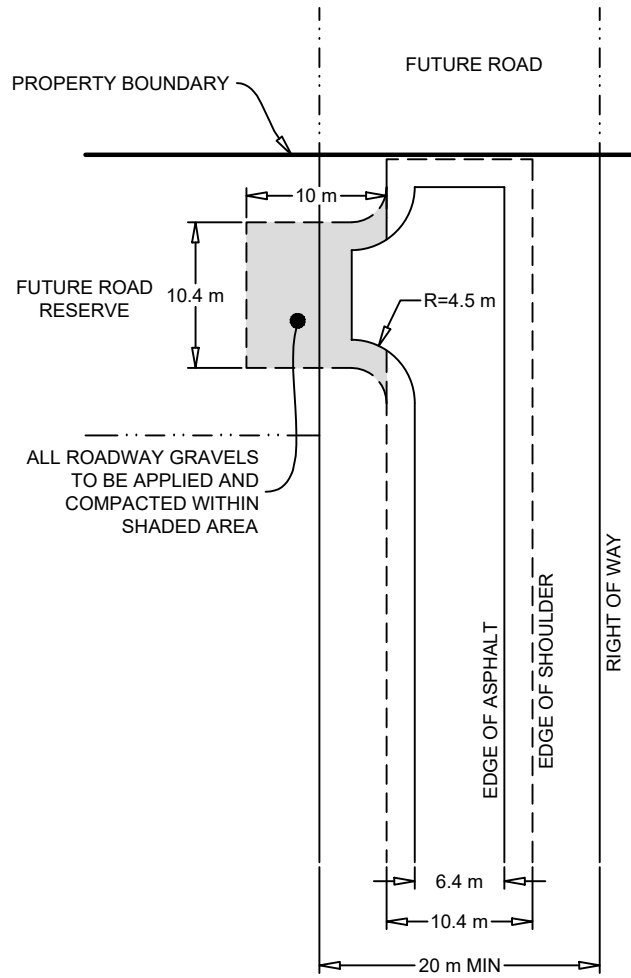

RURAL ROAD
WITHOUT STORM SEWER

NOTES:

1. ALL DIMENSIONS ARE METRIC
2. IF THE DEVELOPER DOES NOT OWN THE PROPERTY BEYOND THE PROPERTY BOUNDARY, A PERMANENT CUL-DE-SAC MUST BE BUILT.



WEST HANTS REGIONAL MUNICIPALITY

STANDARD DETAIL

TEMPORARY TURNING AREA

| | | | |
|-------------|--------------------|----------|--------|
| DATE | September 27, 2022 | SCALE | N.T.S. |
| DRAWING NO. | WH-05 | APPROVED | |

SECTION B-B
CONTROL JOINT

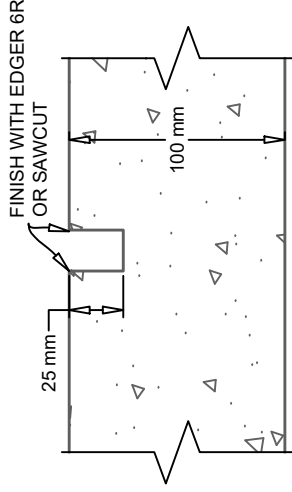

SECTION C-C
EXPANSION JOINT

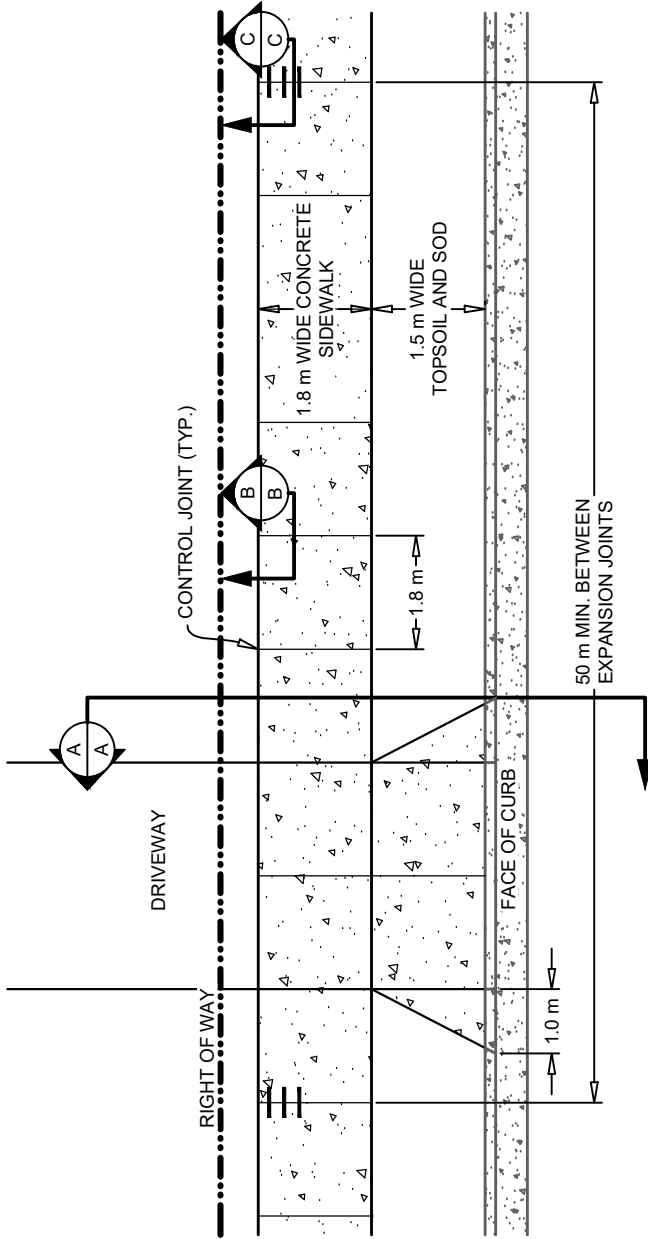
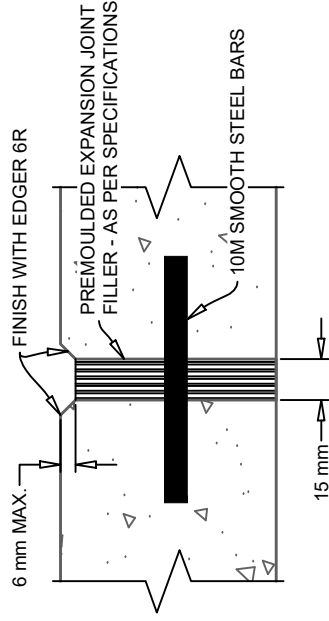

SECTION A-A

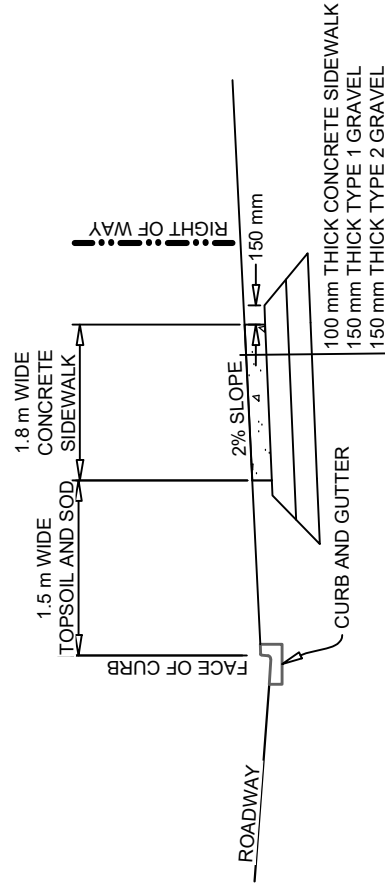

NOTES:

1. CONCRETE SIDEWALK TO BE 100 mm THICK.
2. CONCRETE TO BE 32 MPa AT 28 DAYS
3. CONTROL JOINTS TO AT 1.8 m INTERVALS MAY BE SAW CUT OR HAND TOOLED.
4. EXPANSION JOINTS TO BE PLACED EVERY 50 m.
5. GREASE PORTION OF BARS ON ONE SIDE OF EXPANSION JOINT.
6. DRIVEWAY RAMPS TO BE 150 mm THICK CONCRETE c/w WMM. SEE STANDARD DETAIL WH-07.
7. SIDEWALK BASE COURSE SHALL EXTEND 150 mm OUTSIDE OF EACH EDGE OF THE SIDEWALK.



WEST HANTS REGIONAL MUNICIPALITY

STANDARD DETAIL

TYPICAL SIDEWALK

| | | | |
|-------------|---------------|----------|--------|
| DATE | July 11, 2022 | SCALE | N.T.S. |
| DRAWING NO. | WH-06 | APPROVED | |

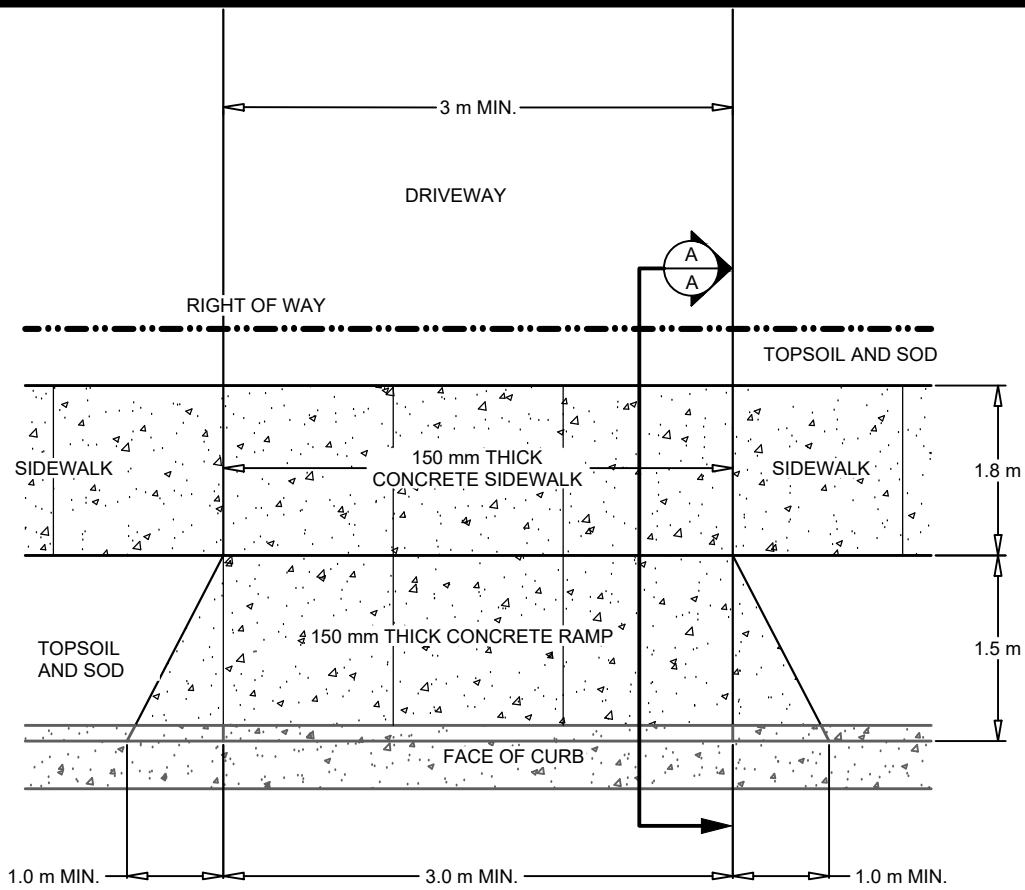

SECTION A-A

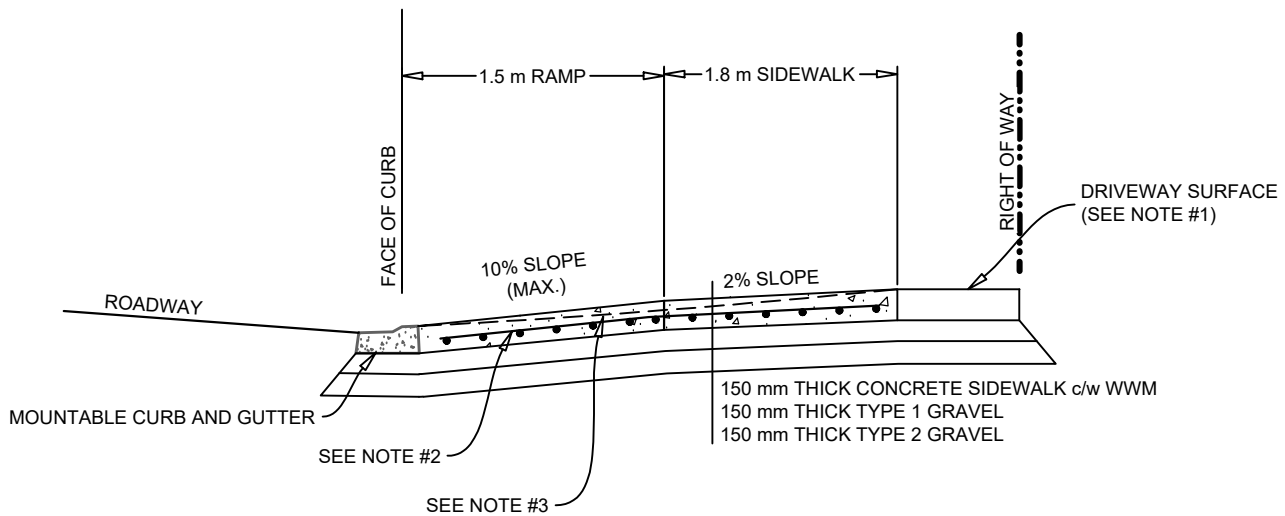

NOTES:

1. FOR DRIVEWAYS PLACE 150x150 mm WELDED WIRE MESH 4 GAUGE PLACED 50 mm FROM BOTTOM OF CONCRETE RAMP AND SIDEWALK.
2. WHEN BOULEVARD IS LESS THAN 1.8 m OR WHEN THE SIDEWALK ABUTS THE CURB & GUTTER, SLOPE SIDEWALK IN A STRAIGHT LINE GRADE FROM BACK OF SIDEWALK TO LIP ON CURB OPENING.
3. MINIMUM DISTANCE BETWEEN CONTROL JOINTS IS 1200 mm. PROVIDE CONTROL JOINTS WITHIN 150 OF CHANGE IN CROSS SECTION CURB



WEST HANTS REGIONAL MUNICIPALITY

STANDARD DETAIL

DRIVEWAY RAMP DETAILS

| | | | |
|-------------|--------------------|----------|--------|
| DATE | September 27, 2022 | SCALE | N.T.S. |
| DRAWING NO. | WH-07 | APPROVED | |

INTERSECTION RAMP

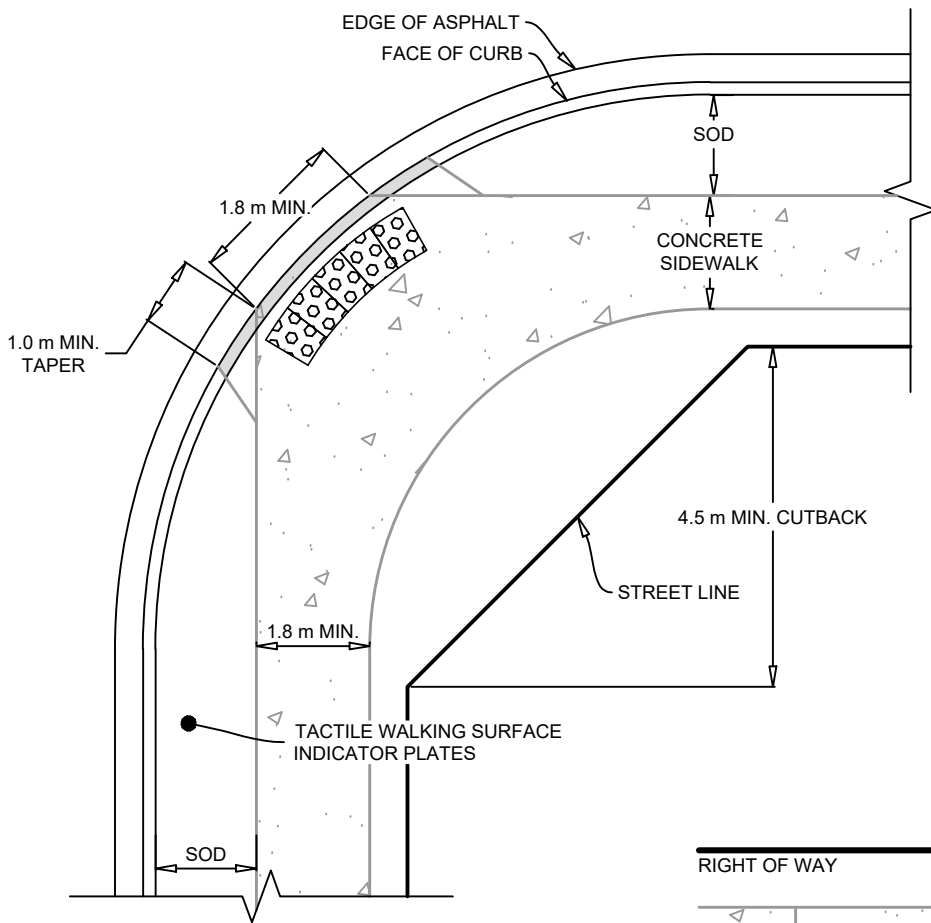

TACTILE WALKING SURFACE INDICATOR PLATE NOTES:

1. NATURAL CAST IRON ATTENTION TWSI (TACTILE WALKING SURFACE INDICATOR) PLATES TO CSA B651, AND AS INDICATED IN THE PROJECT DOCUMENTS.
2. DESIGN AND INSTALLATION MUST MEET ALL ACCESSIBILITY STANDARDS.
3. AT LEAST ONE CORNER OF EACH PLATE TO TOUCH ANOTHER. MAXIMUM GAP BETWEEN EACH PLATE TO BE 150 mm.
4. MAXIMUM GAP BETWEEN PLATES AND START OF TAPER TO BE 100 mm.
5. FOR STREETS OF LESS THAN 8%, TRANSITION CURB AND SIDEWALK TO MAXIMUM GRADE OF 8%, OR TIE IN AT 3 m FOR SIDEWALK, 1.3 m FOR CURB.
6. IF THE DISTANCE FROM BACK OF THE CURB TO BACK OF THE SIDEWALK IS LESS THAN 2.0 m, SLOPE AT 2% FROM BACK OF CURB TO BACK OF SIDEWALK.
7. PLATES SHALL BE PLACED WITH THE TOP OF THE BASE PLATE (BOTTOM OF DOMES) LEVEL WITH CONCRETE SURFACE.
8. ALL PLATES TO BE 610 mm DEEP
9. PEDESTRIAN RAMP OPENING TO BE 1.8 m MINIMUM

MID-BLOCK RAMP

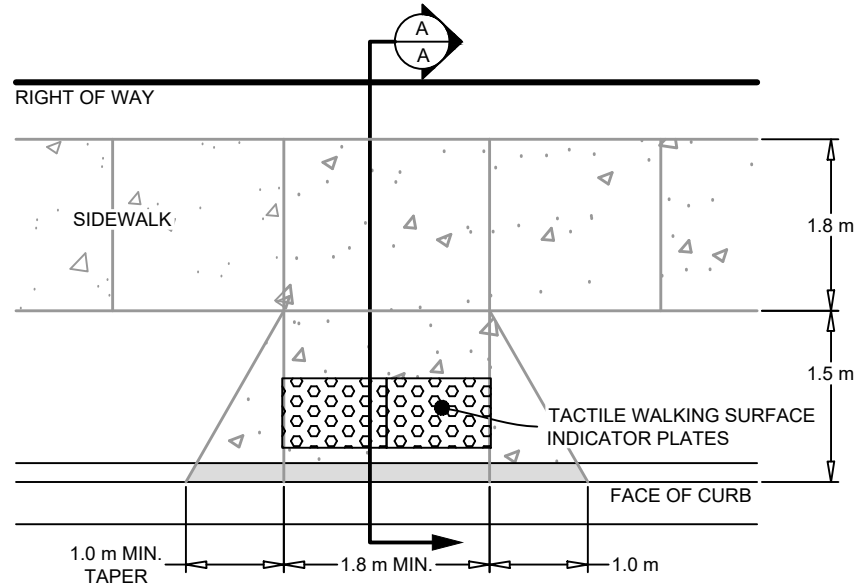

SECTION A-A

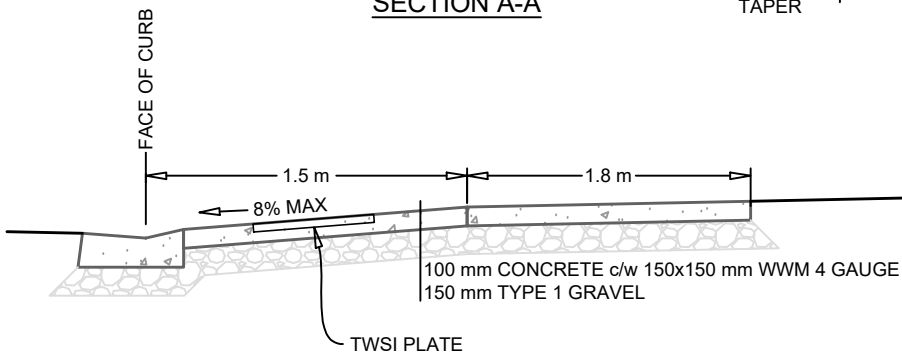

NOTES:

1. CONCRETE TO BE 32 MPa AT 28 DAYS.
2. MINIMUM RAMP WIDTH IS 1.8 m
3. WHERE SIDEWALK ABUTS THE CURB, A 1.0 m TRANSITION TAPER IS REQUIRED IN THE CURB AND SIDEWALK ALONG ITS LENGTH.



WEST HANTS REGIONAL MUNICIPALITY

STANDARD DETAIL

PEDESTRIAN RAMP DETAILS

| DATE | September 27, 2022 | SCALE | N.T.S. |
|-------------|--------------------|----------|--------|
| DRAWING NO. | WH-08 | APPROVED | |

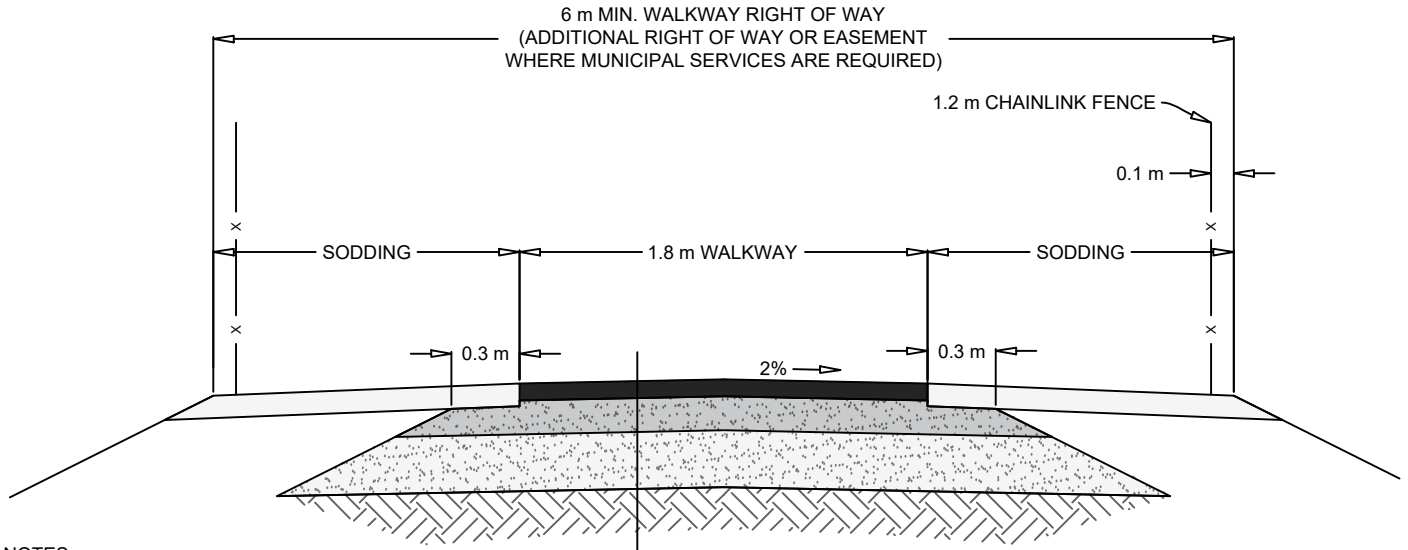

NOTES:

1. WALKWAY SHOULD HAVE MINIMUM LONGITUDINAL SLOPE OF 2% WHERE POSSIBLE.
2. ADDITIONAL R.O.W MAY BE REQUIRED TO ACCOMODATE CUT/FILL SLOPES OR SWALES.
3. TOPSOIL AND SOD TO BE 150 mm THICK.
4. IN LOCATIONS WHERE MAINTENANCE OF SOD IS DIFFICULT, MULCH OR OTHER GROUND COVER MAY BE USED.

100 mm THICK TYPE D-HF ASPHALT
100 mm THICK GRAVEL TYPE 1
200 mm THICK GRAVEL TYPE 2

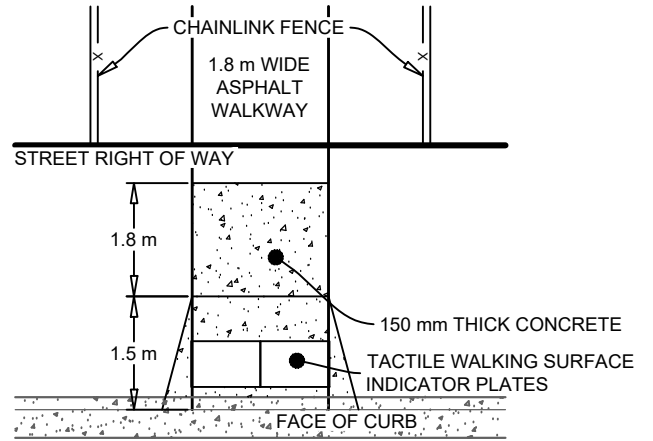
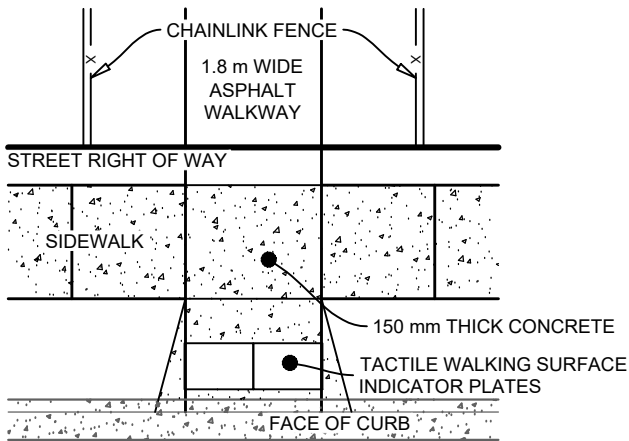

WEST HANTS REGIONAL MUNICIPALITY

STANDARD DETAIL

TYPICAL WALKWAY DETAIL

| | | | |
|-------------|---------------|----------|--------|
| DATE | July 11, 2022 | SCALE | N.T.S. |
| DRAWING NO. | WH-09 | APPROVED | |

PLAN - FILL OR CUT

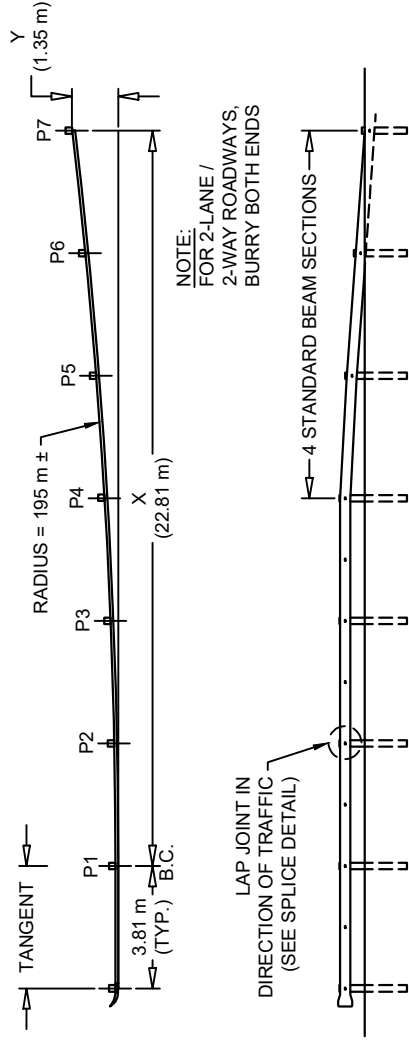

POST OFFSET TABLE

| POST # | X (m) | Y (m) |
|--------|-------|-------|
| P1-P2 | 3.81 | 0.04 |
| P2-P3 | 7.62 | 0.15 |
| P3-P4 | 11.42 | 0.34 |
| P4-P5 | 15.22 | 0.60 |
| P5-P6 | 19.02 | 0.94 |
| P6-P7 | 22.81 | 1.35 |

- NOTES:**
- TWO 50x75 DELINEATORS ARE REQUIRED FOR EACH POST.
 - A WHITE DELINEATOR SHALL BE PLACED ON THE SIDE OF THE POST FACING TRAFFIC.
 - A YELLOW DELINEATOR SHALL BE PLACED ON THE OPPOSITE SIDE.
 - THE DELINEATOR SHALL BE LOCATED AT THE EDGE OF THE POST NEAREST THE ROAD, VERTICAL, WITH THE TOP 75 BELOW THE LOWEST POINT OF THE GUARDRAIL PANEL.
 - THE DELINEATOR SHALL BE ATTACHED WITH GALVANIZED NAILS.

SPLICE DETAIL

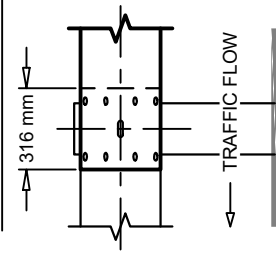

BEAM SECTION (TYP.)

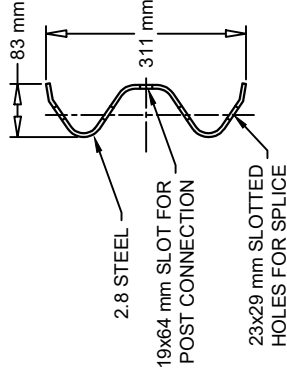

TERMINAL END

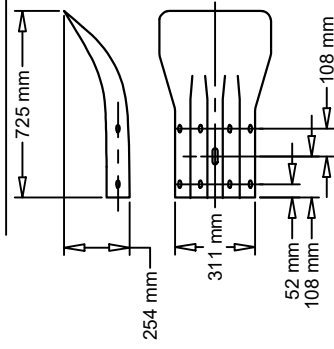

BUFFER END

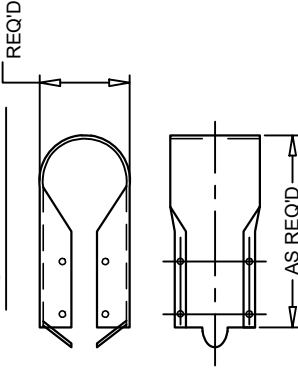

ELEVATION

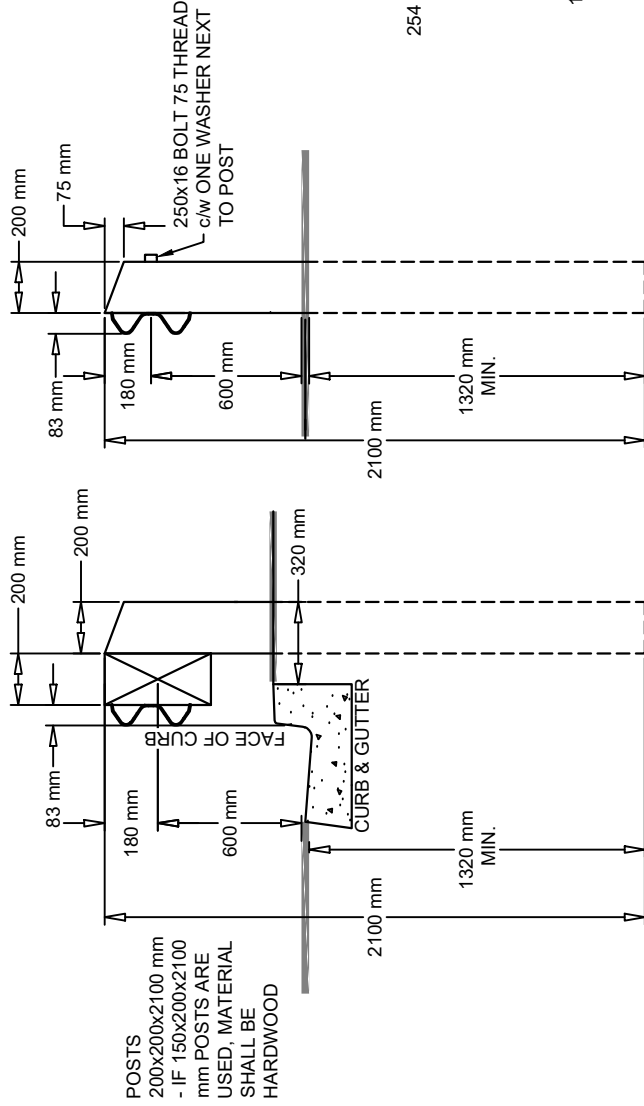

WEST HANTS REGIONAL MUNICIPALITY

STANDARD DETAIL

GUARD RAIL INSTALLATION

| | | | |
|-------------|--------------------|----------|--------|
| DATE | September 27, 2022 | SCALE | N.T.S. |
| DRAWING NO. | WH-10 | APPROVED | |

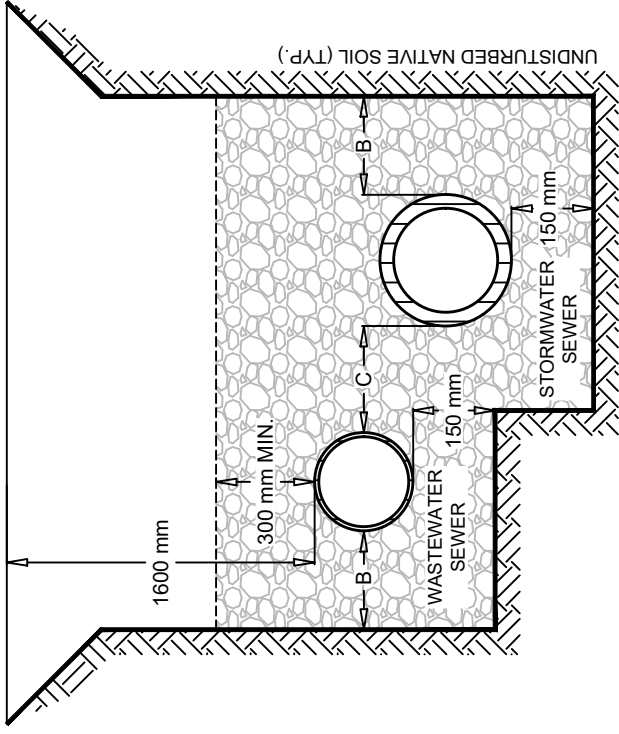
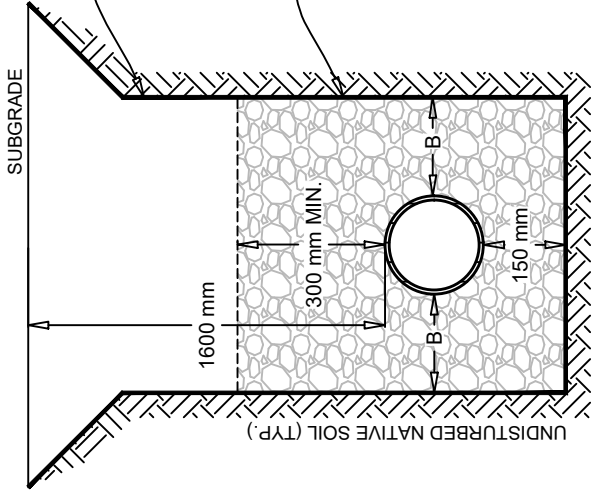

| PIPE SIZE NOM. DIA. | DIMENSIONS (mm) | |
|---------------------|-----------------|-----|
| | B | C |
| UP TO 375 mm | 300 | 250 |
| 376 TO 500 mm | 300 | 300 |
| 501 TO 750 mm | 400 | 300 |
| 751 TO 1200 mm | 400 | 400 |

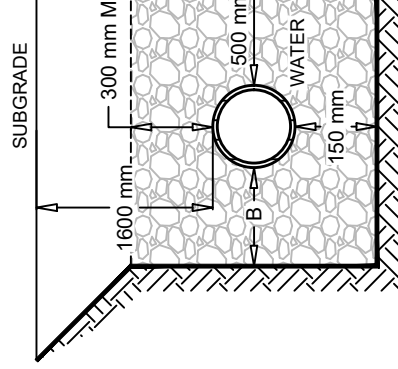

NOTES

1. DIMENSION "C" IS GOVERNED BY THE LARGER PIPE DIAMETER.
2. SIDES OF TRENCHES TO REQUIREMENTS OF NOVA SCOTIA OCCUPATIONAL HEALTH AND SAFETY ACT.
3. IF CROWNS OF STORMWATER AND WASTEWATER SEWER ARE NOT MATCHED, THE INVERT OF THE STORMWATER SEWER MUST BE AT LEAST 100 mm BELOW THE INVERT OF THE WASTEWATER SEWER.
4. MINIMUM GRAVEL COVER OVER WASTEWATER AND STORMWATER SEWERS IS TO BE 300 mm.

SEE NOTE 3



WEST HANTS REGIONAL MUNICIPALITY

STANDARD DETAIL

TRENCH AND BACKFILL CROSS SECTIONS

| | | | | |
|-------------|--------------------|-------|----------|--------|
| DATE | September 27, 2022 | SCALE | APPROVED | N.T.S. |
| DRAWING NO. | WH-11 | | | |

IMP C-56M ADJUSTABLE FRAME w/ R-10 COVER
CENTERED ON UPSTREAM SIDE.

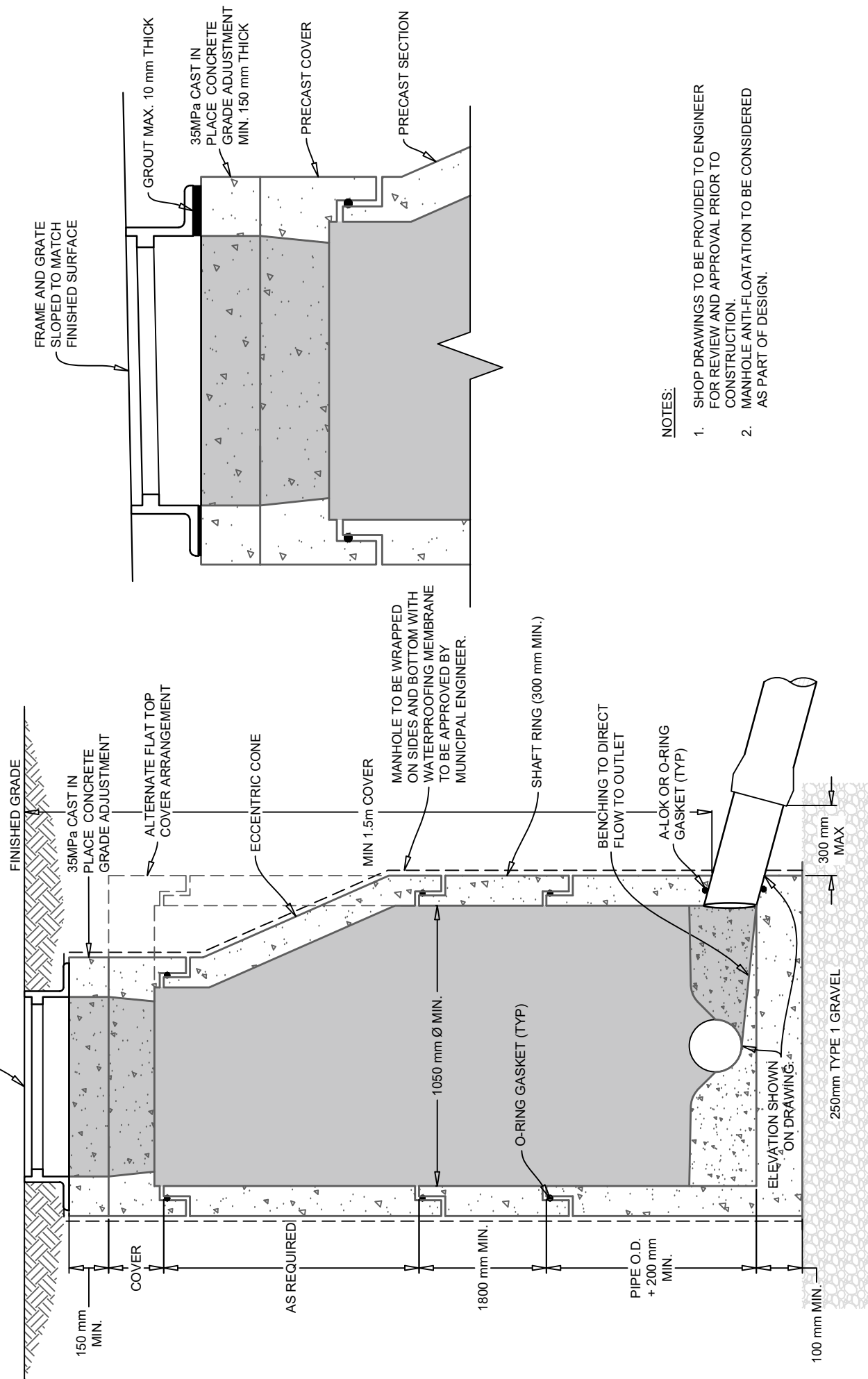

FRAME AND GRATE
SLOPED TO MATCH
FINISHED SURFACE

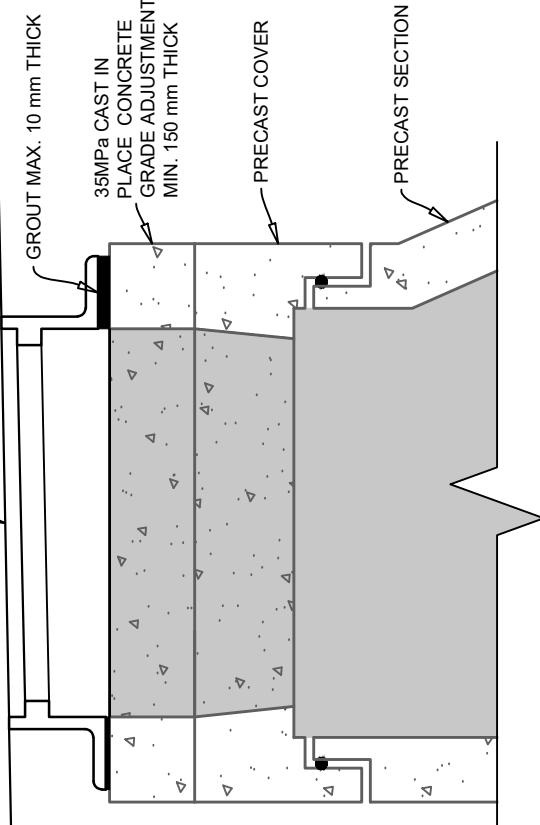

NOTES:

1. SHOP DRAWINGS TO BE PROVIDED TO ENGINEER FOR REVIEW AND APPROVAL PRIOR TO CONSTRUCTION.
2. MANHOLE ANTI-FLOATATION TO BE CONSIDERED AS PART OF DESIGN.



WEST HANTS REGIONAL MUNICIPALITY

STANDARD DETAIL

PRECAST MANHOLE

| | | | |
|-------------|--------------------|----------|--------|
| DATE | September 27, 2022 | SCALE | N.T.S. |
| DRAWING NO. | WH-12 | APPROVED | |

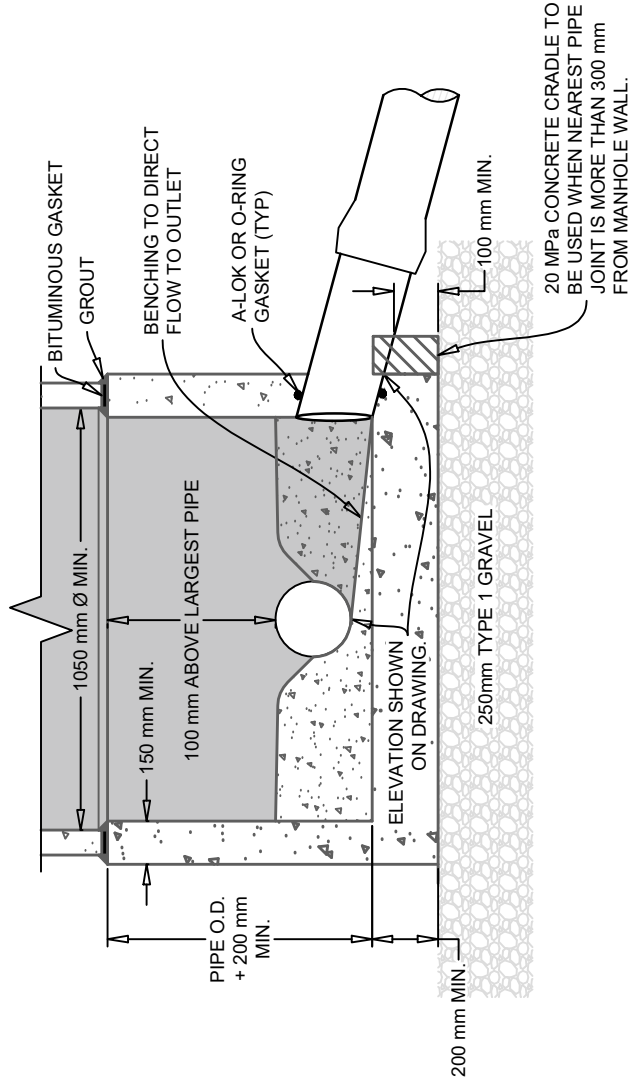
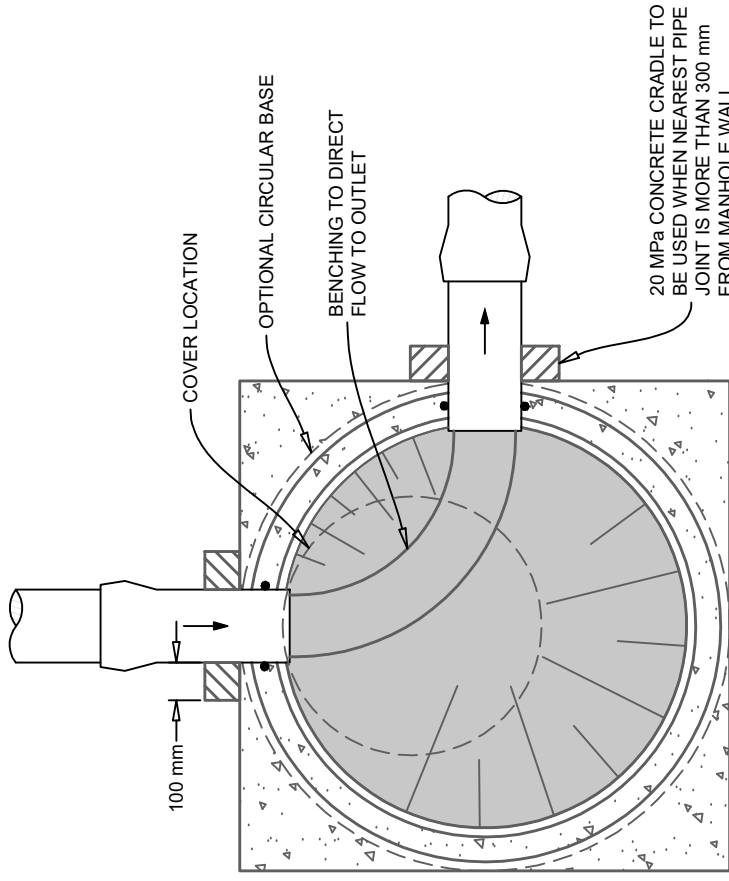

WEST HANTS REGIONAL MUNICIPALITY

STANDARD DETAIL

CAST-IN-PLACE BASE FOR PRECAST MANHOLE

DATE September 27, 2022

DRAWING NO. WH-13

SCALE

N.T.S.

APPROVED

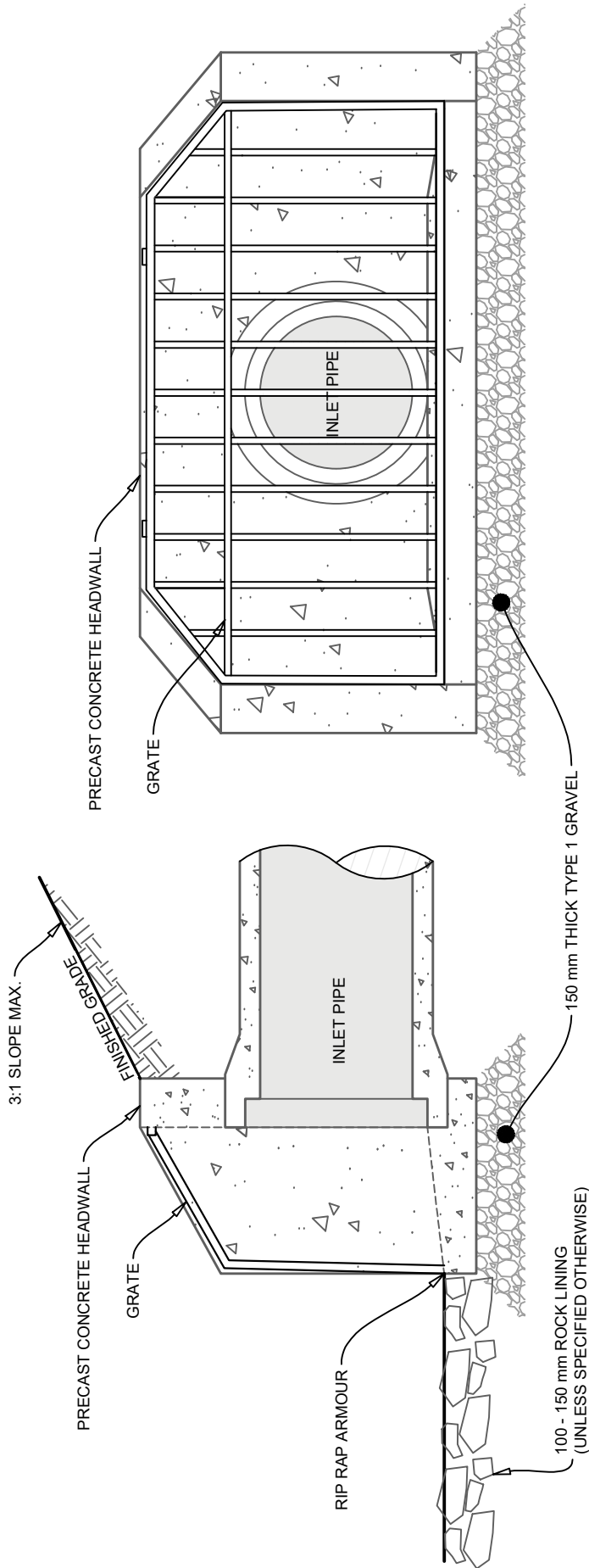

NOTES:

1. ANY PIPE SYSTEMS OR CULVERTS LONGER THAN 30 m TO HAVE HEADWALL GRATES ON INLETS.
2. BARS TO BE VERTICAL ON INLET GRATES. GRATES ARE NOT PERMITTED ON OUTLETS.
3. AREA OF HEADWALL GRATE (WHERE REQUIRED) TO BE MINIMUM 6 TIME LARGER THAN PIPE CROSS SECTIONAL AREA.
4. GRATES TO BE GALVANIZED STEEL.
5. HEADWALL TO BE SIZED BASED ON PIPE SIZE AS PER PRECAST MANUFACTURER'S RECOMMENDATION.
6. FENCING/HANDRAIL ON TOP OF HEADWALL AS DIRECTED BY MUNICIPALITY.



WEST HANTS REGIONAL MUNICIPALITY
STANDARD DETAIL

| | |
|---------------------------|--------------------|
| PRECAST CONCRETE HEADWALL | |
| DATE | September 27, 2022 |
| DRAWING NO. | WH-14 |
| SCALE | APPROVED |
| N.T.S. | |

NOTES:

1. ANODE TO BE ZINC 24-48 TYPE INSTALLED BY USE OF DOUBLE NUT.
2. HYDRANT TO BE CLOW/McAVITY M67 BRIGADIER OR APPROVED EQUIVALENT.
 - HYDRANT INLET: 150 mm MECHANICAL JOINT OR APPROVED EQUIVALENT
 - HOSE NOZZLES: 2x65 mm THREADED OR APPROVED EQUIVALENT
 - PUMPER NOZZLE: 114 mm THREADED OR APPROVED EQUIVALENT
3. USE ONLY APPROVED PRODUCTS FOR MECHANICAL RESTRAINT.

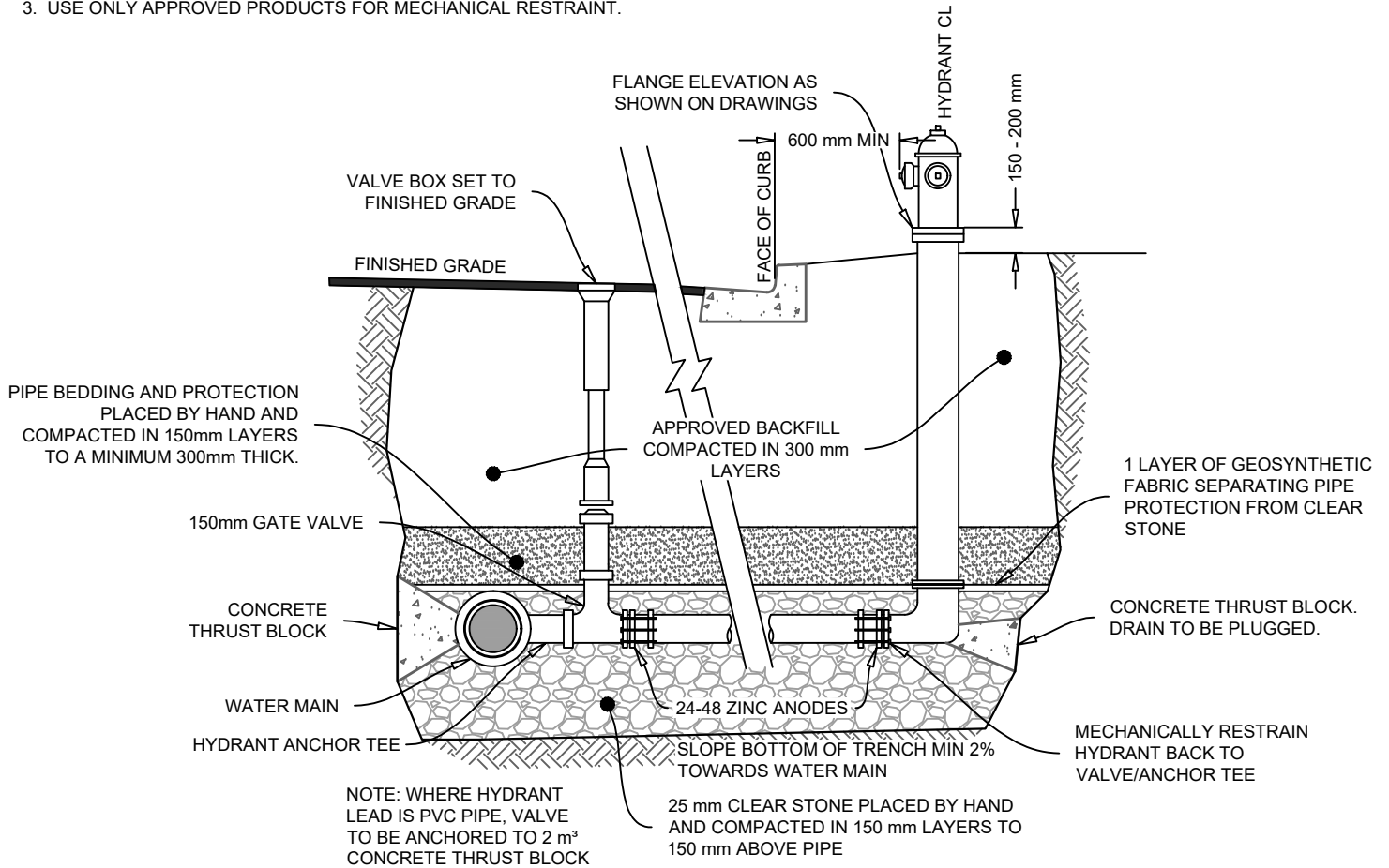

WEST HANTS REGIONAL MUNICIPALITY

STANDARD DETAIL

FIRE HYDRANT INSTALLATION - FULLY SERVICED

| | | | |
|-------------|--------------------|----------|--------|
| DATE | September 27, 2022 | SCALE | N.T.S. |
| DRAWING NO. | WH-15 | APPROVED | |

NOTES:

1. FOR WATER MAIN SIZES LARGER THAN 300 mm, CHAMBER DIAMETER SHALL BE 1500 mm. FOR WATER MAIN SIZES LARGER THAN 600 mm, THE CHAMBER WILL BE DESIGNED SPECIFICALLY FOR THE INSTALLATION.
2. WHERE DITCHING IS APPLICABLE, VENT PIPE IS TO BE LOCATED ON PRIVATE SIDE OF DITCH. INSTALL CULVERT IF NECESSARY.
3. PVC SCH80 IS PERMITTED FOR BURIED VENT PIPING.

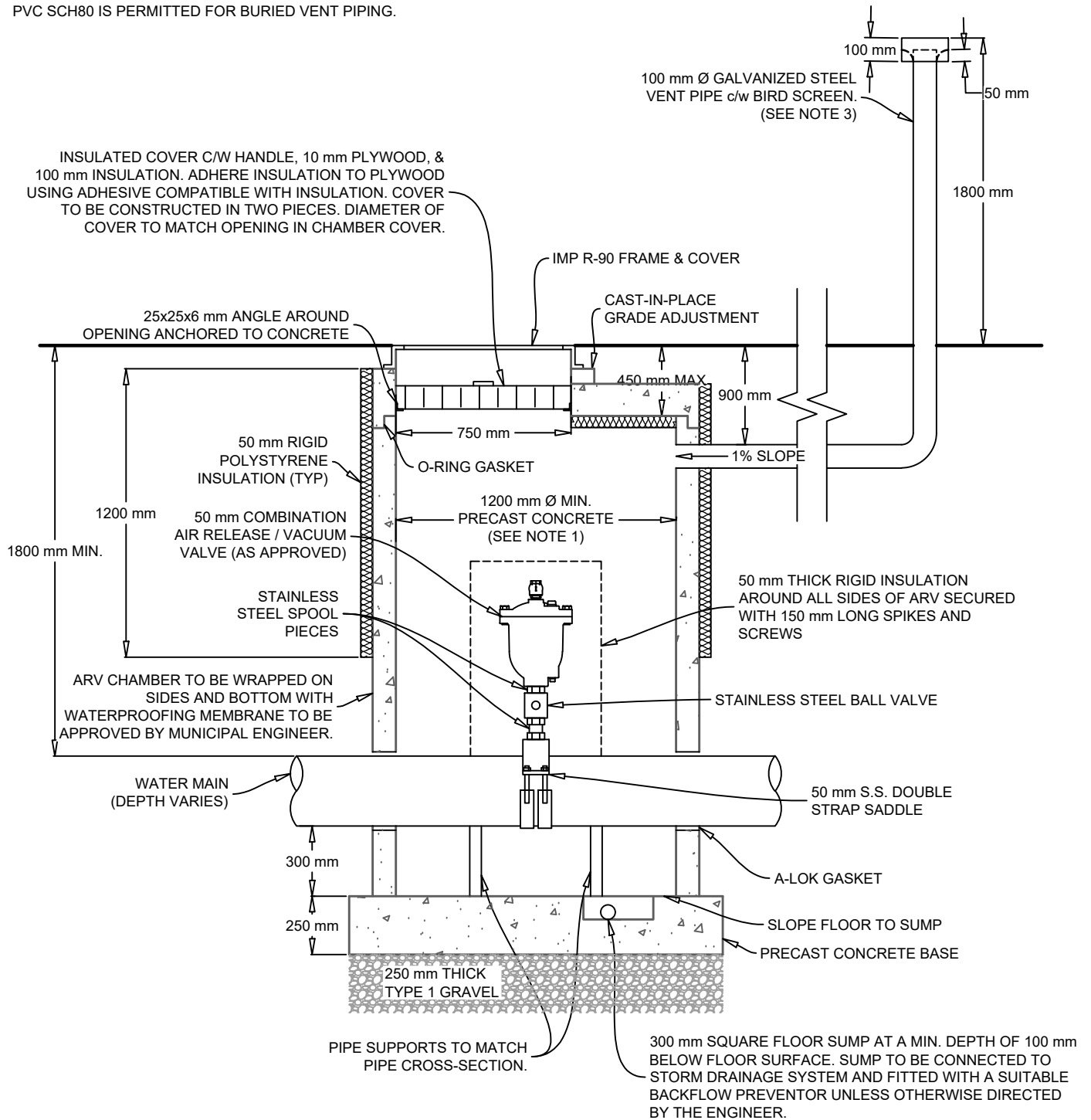
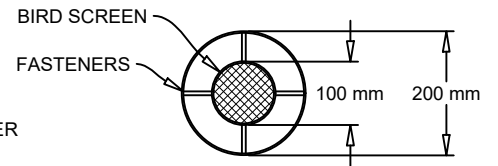

| | | | |
|--|--------------------|----------|--------|
| WEST HANTS REGIONAL MUNICIPALITY | | | |
| STANDARD DETAIL | | | |
| RESIDENTIAL AIR RELEASE/AIR VACUUM VALVE CHAMBER (50 mm) | | | |
| DATE | September 27, 2022 | SCALE | N.T.S. |
| DRAWING NO. | WH-17 | APPROVED | |

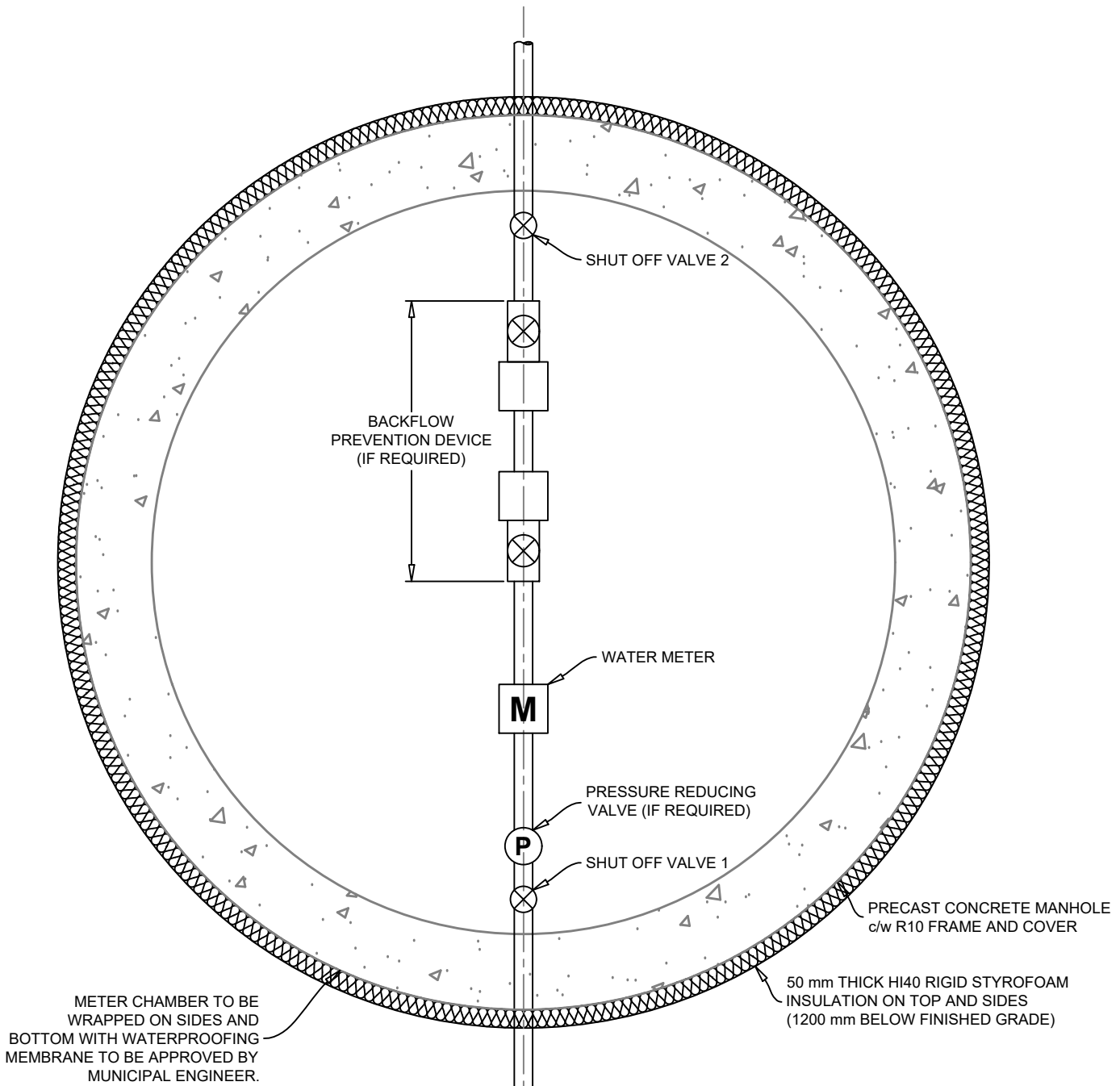

METER CHAMBER TO BE WRAPPED ON SIDES AND BOTTOM WITH WATERPROOFING MEMBRANE TO BE APPROVED BY MUNICIPAL ENGINEER.

NOTES:

1. ALL PIPE, MANHOLE, FRAME AND COVER, VALVES, AND FITTINGS TO BE SUPPLIED BY CONTRACTOR. WATER METER TO BE SUPPLIED BY WEST HANTS
2. MANHOLE DIAMETER TO BE 2400 mm WITH B.F.P, 1800 mm WITHOUT B.F.P.
3. CONTRACTOR TO INSTALL CONDUIT AND SUPPORT/PROTECTION FOR REMOTE REGISTER, SUBJECT TO APPROVAL BY MUNICIPALITY OF WEST HANTS.
4. MINIMUM DEPTH OF METER FROM FINISHED GRADE 1600 mm.
5. INSULATION IS REQUIRED. SEE WH-16 FOR DETAILS.

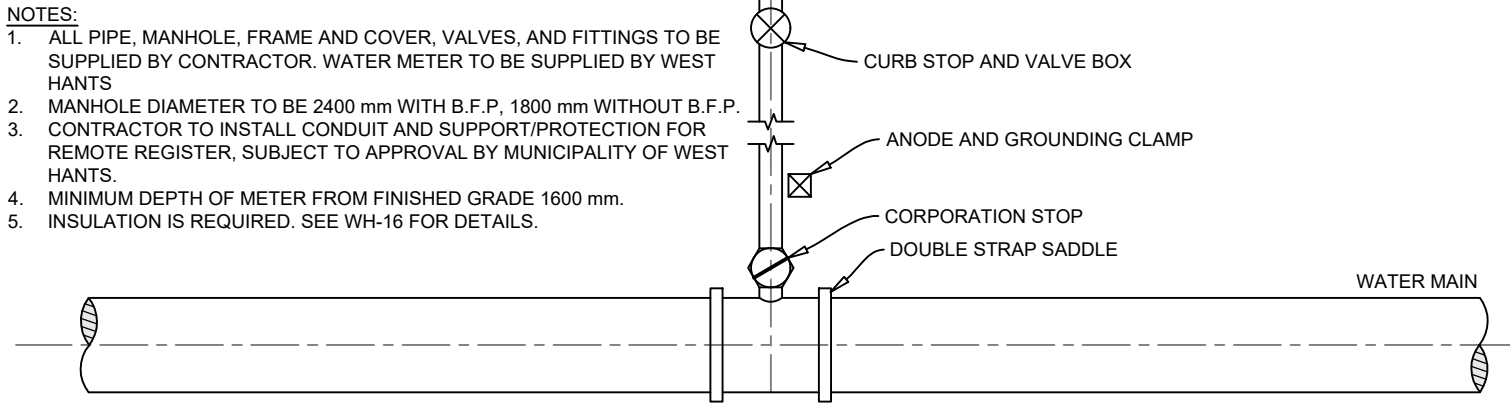

| | | | |
|--|--------------------|----------|--------|
| WEST HANTS REGIONAL MUNICIPALITY | | | |
| STANDARD DETAIL | | | |
| PLAN OF 19 mm TO 50 mm WATER METER CHAMBER | | | |
| DATE | September 27, 2022 | SCALE | N.T.S. |
| DRAWING NO. | WH-18 | APPROVED | |

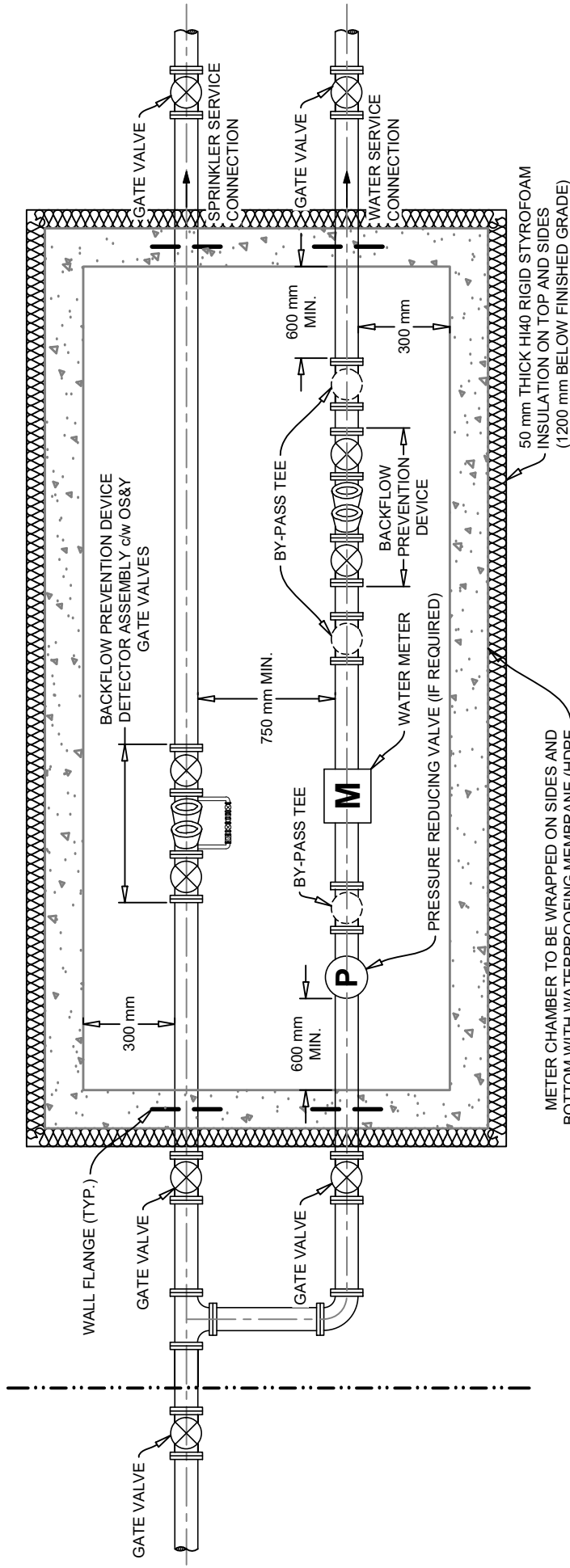

METER CHAMBER TO BE WRAPPED ON SIDES AND BOTTOM WITH WATERPROOFING MEMBRANE (HDPE DIMPLE MEMBRANE OR APPROVED EQUIVALENT).

NOTES:

1. ALL NOTED DIMENSIONS/SPACING REQUIREMENTS WITH REGARDS TO CHAMBER WALLS.
2. REDUCED PRESSURE PRINCIPLE BACKFLOW PREVENTION DEVICES ARE NOT PERMITTED IN BELOW GRADE CHAMBERS.
3. ALL GATE VALVES TO BE ACCESSIBLE FROM SURFACE.



WEST HANTS REGIONAL MUNICIPALITY

STANDARD DETAIL

| | | | |
|---|--------------------|-------|----------|
| 75 mm & GREATER WATER METER AND BACKFLOW PREVENTION DEVICES | | SCALE | APPROVED |
| DATE | September 27, 2022 | | |
| DRAWING NO. | WH-19 | | |
| | | | N.T.S. |

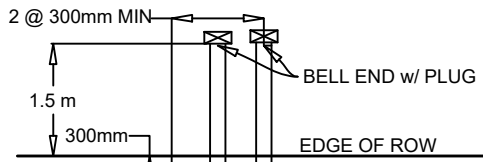

NOTE:
 WHERE SIDEWALK IS PRESENT, EXTEND ALL LATERALS AND CURB STOPS 1 m MIN. BEYOND THE OUTSIDE EDGE OF THE SIDEWALK.

WHERE BEDROCK IS PRESENT, CONTRACTOR TO BREAK ROCK 1.5 m MIN. BEYOND END OF LATERALS.

INSTALL 2" x 4" TIMBER MARKER FROM PIPE ENDS TO MINIMUM 600 mm ABOVE GRADE. MARKERS TO BE PAINTED AND LABELED AS FOLLOWS:

| LATERAL | COLOUR | LABEL |
|----------|--------|-------|
| WATER | BLUE | WATER |
| SANITARY | RED | SAN |
| STORM | GREEN | STORM |

MARKERS TO BE INSTALLED NEATLY AND EVENLY SPACED IN A VERTICAL ORIENTATION WITH LABELS FACING THE STREET.

CONNECTION TO BE INLINE PVC TEE WHEN CONNECTING TO PVC MAIN OR KOR-N-TEE WHEN CONNECTING TO CONCRETE.

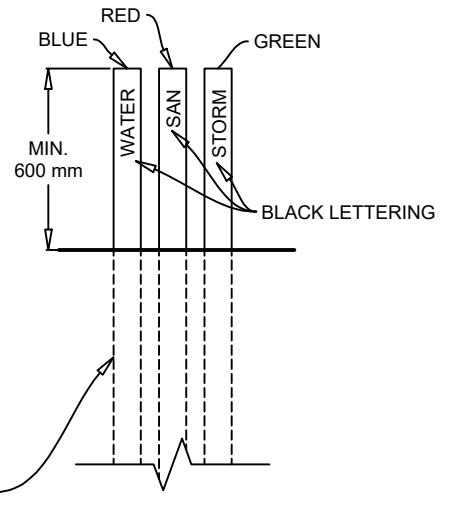
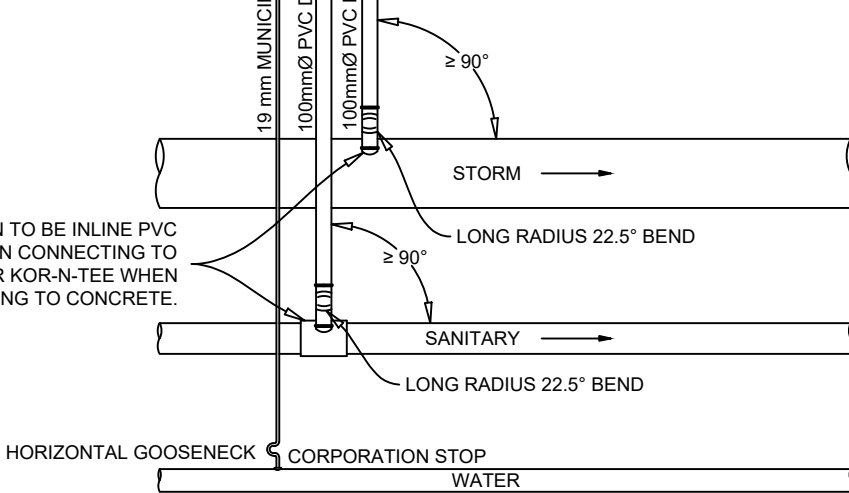

WEST HANTS REGIONAL MUNICIPALITY

STANDARD DETAIL

SINGLE FAMILY UNIT SERVICE LATERALS

| | | | |
|-------------|--------------------|----------|--------|
| DATE | September 27, 2022 | SCALE | N.T.S. |
| DRAWING NO. | WH-20 | APPROVED | |

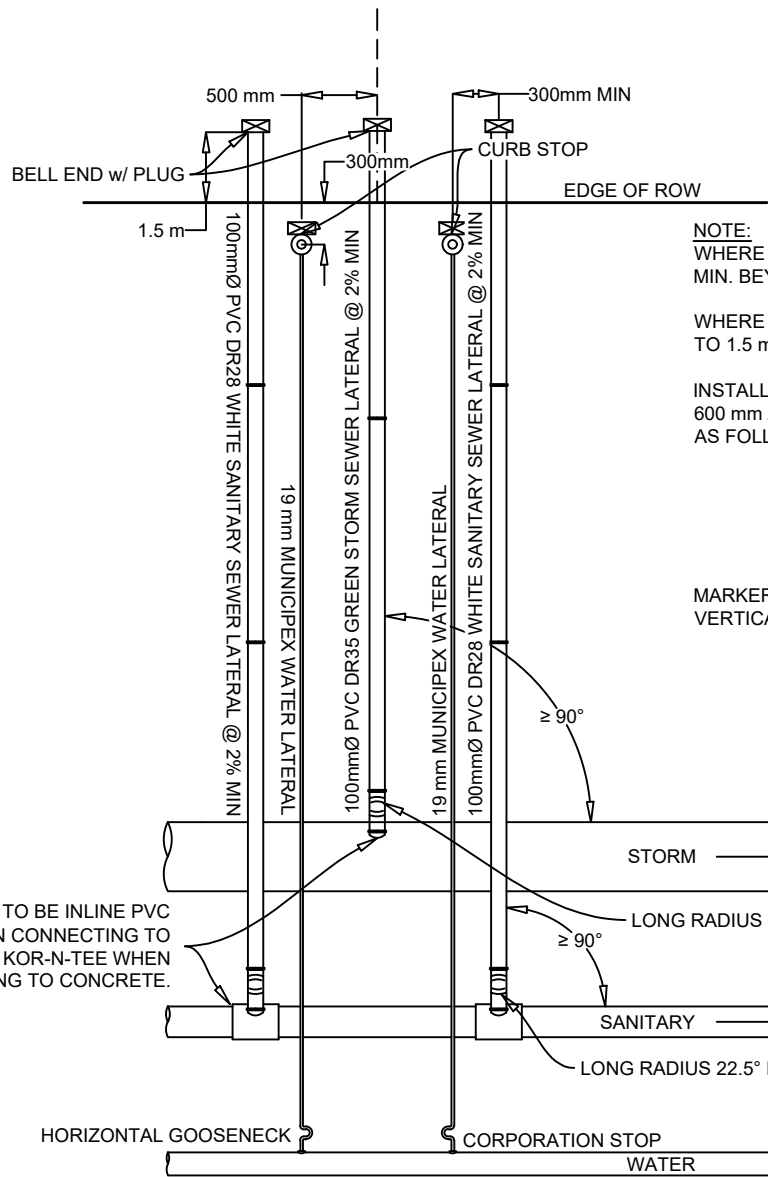

NOTE:
 WHERE SIDEWALK IS PRESENT, CURB STOP TO BE LOCATED 1 m MIN. BEYOND THE OUTSIDE EDGE OF THE SIDEWALK.

WHERE BEDROCK IS PRESENT, CONTRACTOR TO BREAK ROCK TO 1.5 m MIN. BEYOND END OF LATERALS.

INSTALL 2" x 4" TIMBER MARKER FROM PIPE ENDS TO MINIMUM 600 mm ABOVE GRADE. MARKERS TO BE PAINTED AND LABELED AS FOLLOWS:

| LATERAL | COLOUR | LABEL |
|----------|--------|-------|
| WATER | BLUE | WATER |
| SANITARY | RED | SAN |
| STORM | GREEN | STORM |

MARKERS TO BE INSTALLED NEATLY AND EVENLY SPACED IN A VERTICAL ORIENTATION WITH LABELS FACING THE STREET.

CONNECTION TO BE INLINE PVC TEE WHEN CONNECTING TO PVC MAIN OR KOR-N-TEE WHEN CONNECTING TO CONCRETE.

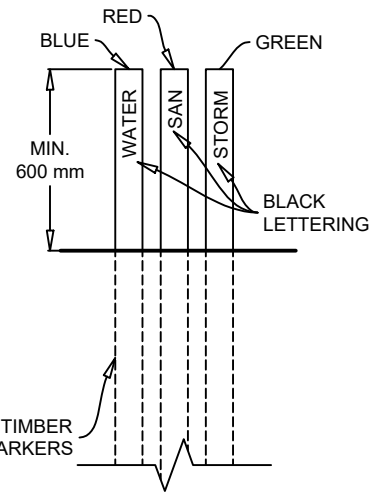

| | | | |
|---|--------------------|----------|--------|
| WEST HANTS REGIONAL MUNICIPALITY | | | |
| STANDARD DETAIL | | | |
| SEMI-DETACHED UNIT SERVICE LATERALS | | | |
| DATE | September 27, 2022 | SCALE | N.T.S. |
| DRAWING NO. | WH-21 | APPROVED | |

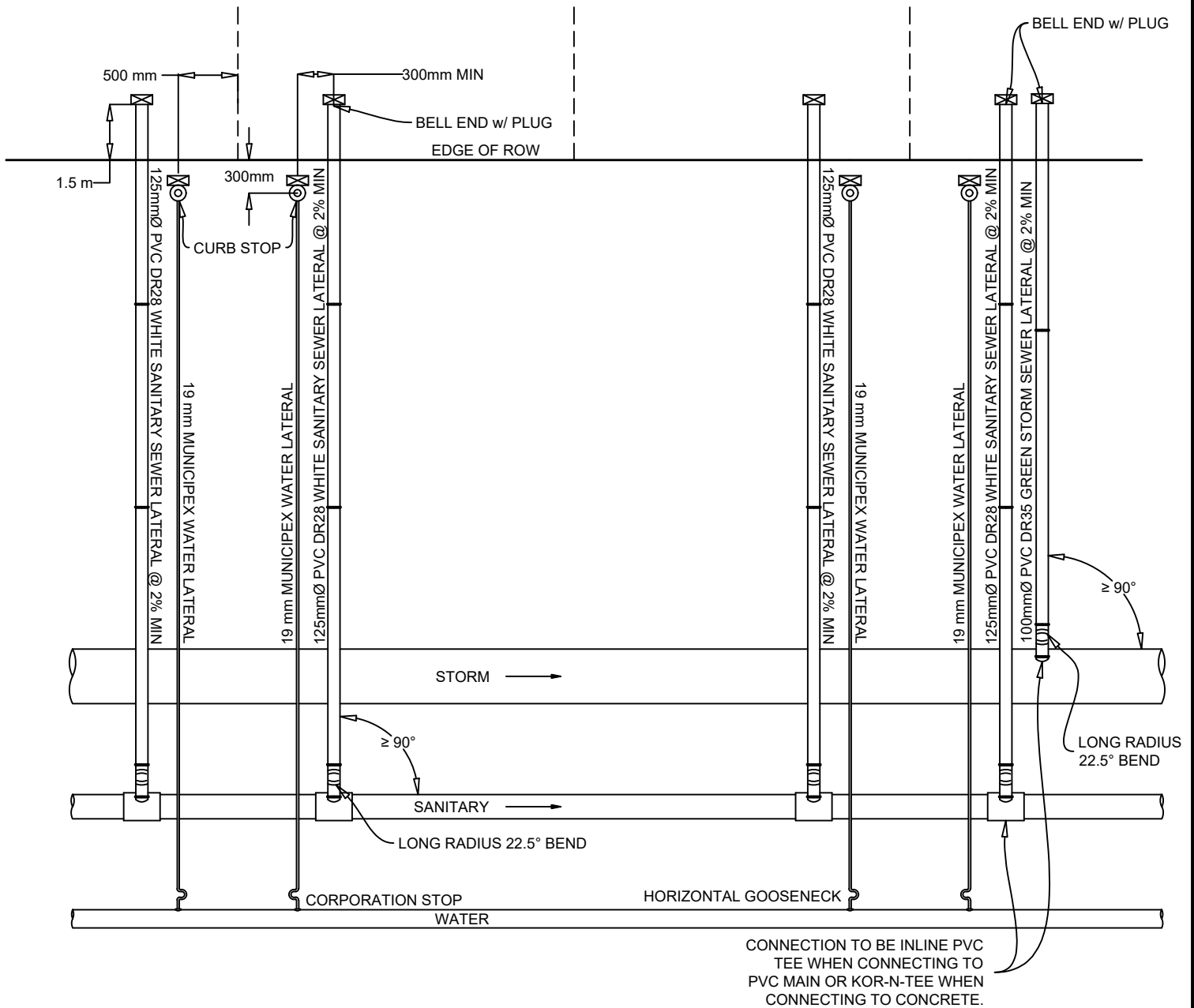

NOTE:
 WHERE SIDEWALK IS PRESENT, CURB STOP TO BE LOCATED 1 m MIN. BEYOND THE OUTSIDE EDGE OF THE SIDEWALK.

INSTALL ONE STORM LATERAL FOR EACH TOWNHOUSE BLOCK AT THE DOWNSTREAM END OF BLOCK.

WHERE BEDROCK IS PRESENT, CONTRACTOR TO BREAK ROCK 1.5 m MIN. BEYOND END OF LATERALS.

INSTALL 2" x 4" TIMBER MARKER FROM PIPE ENDS TO MINIMUM 600 mm ABOVE GRADE. MARKERS TO BE PAINTED AND LABELED AS FOLLOWS:

| LATERAL | COLOUR | LABEL |
|----------|--------|-------|
| WATER | BLUE | WATER |
| SANITARY | RED | SAN |
| STORM | GREEN | STORM |

MARKERS TO BE INSTALLED NEATLY AND EVENLY SPACED IN A VERTICAL ORIENTATION WITH LABELS FACING THE STREET.

CONNECTION TO BE INLINE PVC TEE WHEN CONNECTING TO PVC MAIN OR KOR-N-TEE WHEN CONNECTING TO CONCRETE.

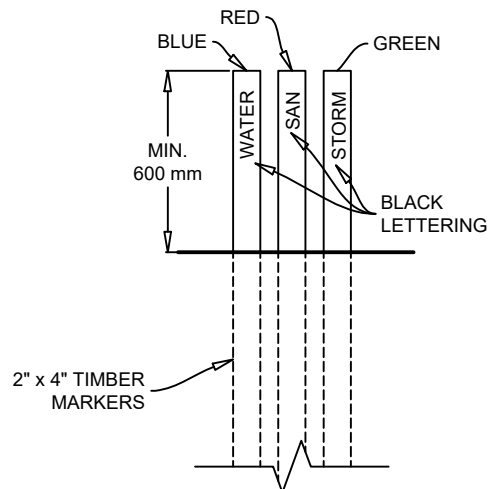

| | | | |
|---|--------------------|----------|--------|
| WEST HANTS REGIONAL MUNICIPALITY | | | |
| STANDARD DETAIL | | | |
| TOWNHOUSE UNIT SERVICE LATERALS | | | |
| DATE | September 27, 2022 | SCALE | N.T.S. |
| DRAWING NO. | WH-22 | APPROVED | |

DETAIL 1 HORIZONTAL GOOSENECK

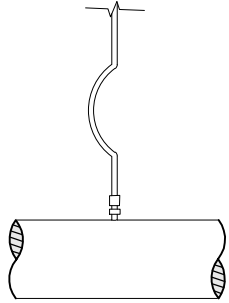

NOTES:

1. MINIMUM 300 mm VERTICAL AND HORIZONTAL SEPARATION TO BE MAINTAINED BETWEEN WATER AND WASTEWATER / STORMWATER PIPES.
2. SERVICES BOXES TO HAVE S.S. OPERATING RODS AND COTTER PINS.
3. PLACE SELECT BACKFILL MATERIAL, MAX. 50 mm AROUND SERVICE BOX TO SUB GRADE.
4. TAPE POLYWRAPPING AT TAP LOCATION
5. PROVIDE 6.0 m HORIZONTAL SEPARATION FROM ANY PORTION OF A WASTEWATER DISPOSAL FIELD.
6. MINIMUM SERVICE SIZE OF MUNICIPEX SERVICE PIPE IS 19 mm.
7. INSULATION REQUIRED WHERE COVER IS LESS THAN 1.6 m.

ROD
↑

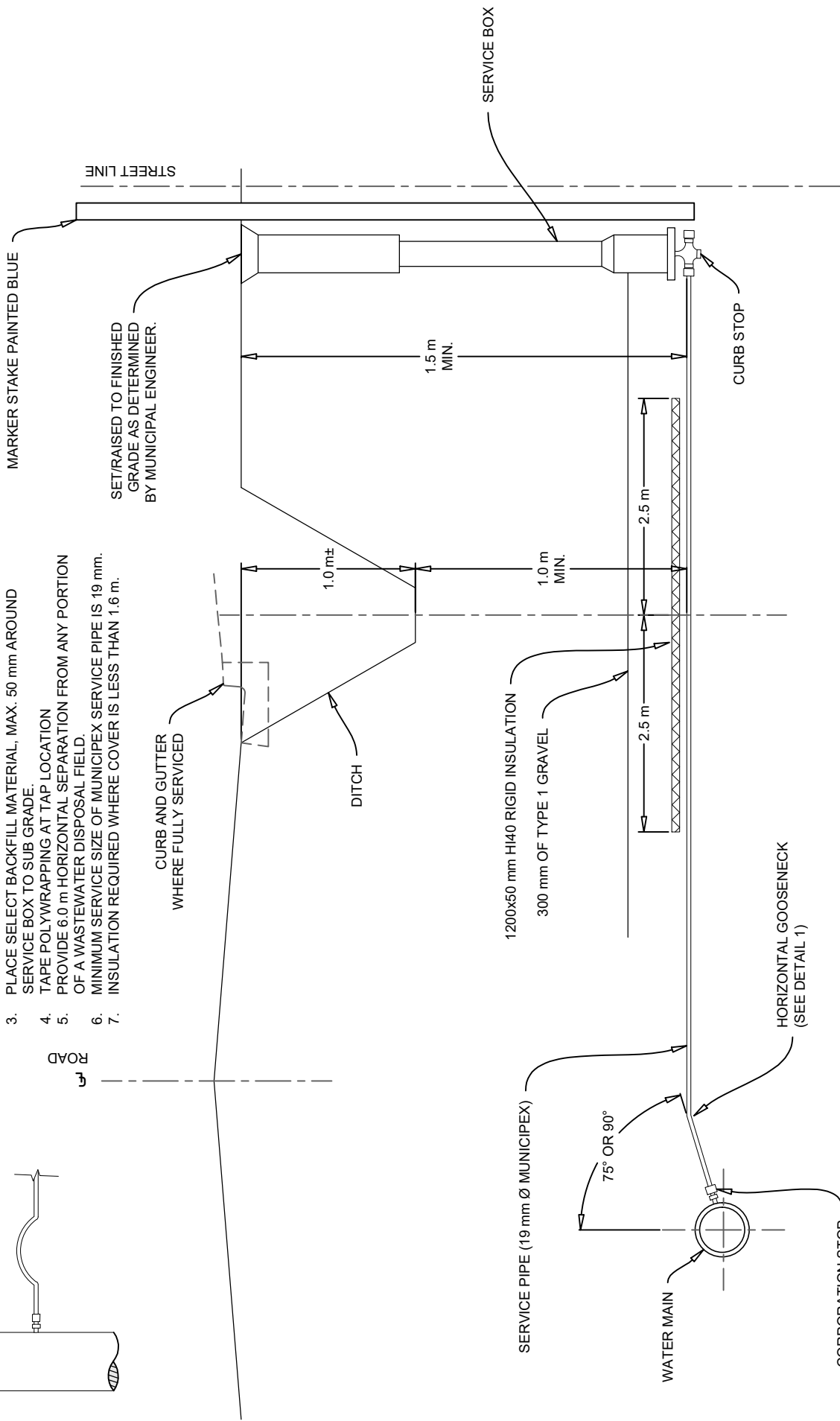

WEST HANTS REGIONAL MUNICIPALITY

STANDARD DETAIL

TYPICAL WATER SERVICE CONNECTION

DATE September 27, 2022

DRAWING NO. WH-23

SCALE

APPROVED

N.T.S.

MARKER POSTS PAINTED
RED FOR SANITARY AND
GREEN FOR STORM

STREET LINE

FINISHED GRADE

NOTES:

1. STORM LATERAL TO BE 100 mm PVC DR18 WHERE 450 mm SEPARATION FROM WATER MAIN CANNOT BE ACHIEVED.
2. SANITARY LATERAL TO BE 100 mm PVC DR18 WHERE 450 mm SEPARATION FROM WATER MAIN CANNOT BE ACHIEVED.
3. SERVICE LATERALS TO BE CONNECTED TO PVC MAINS WITH IN-LINE TEES AND CONCRETE MAINS WITH KOR-N-TEE OR APPROVED EQUIVALENT.

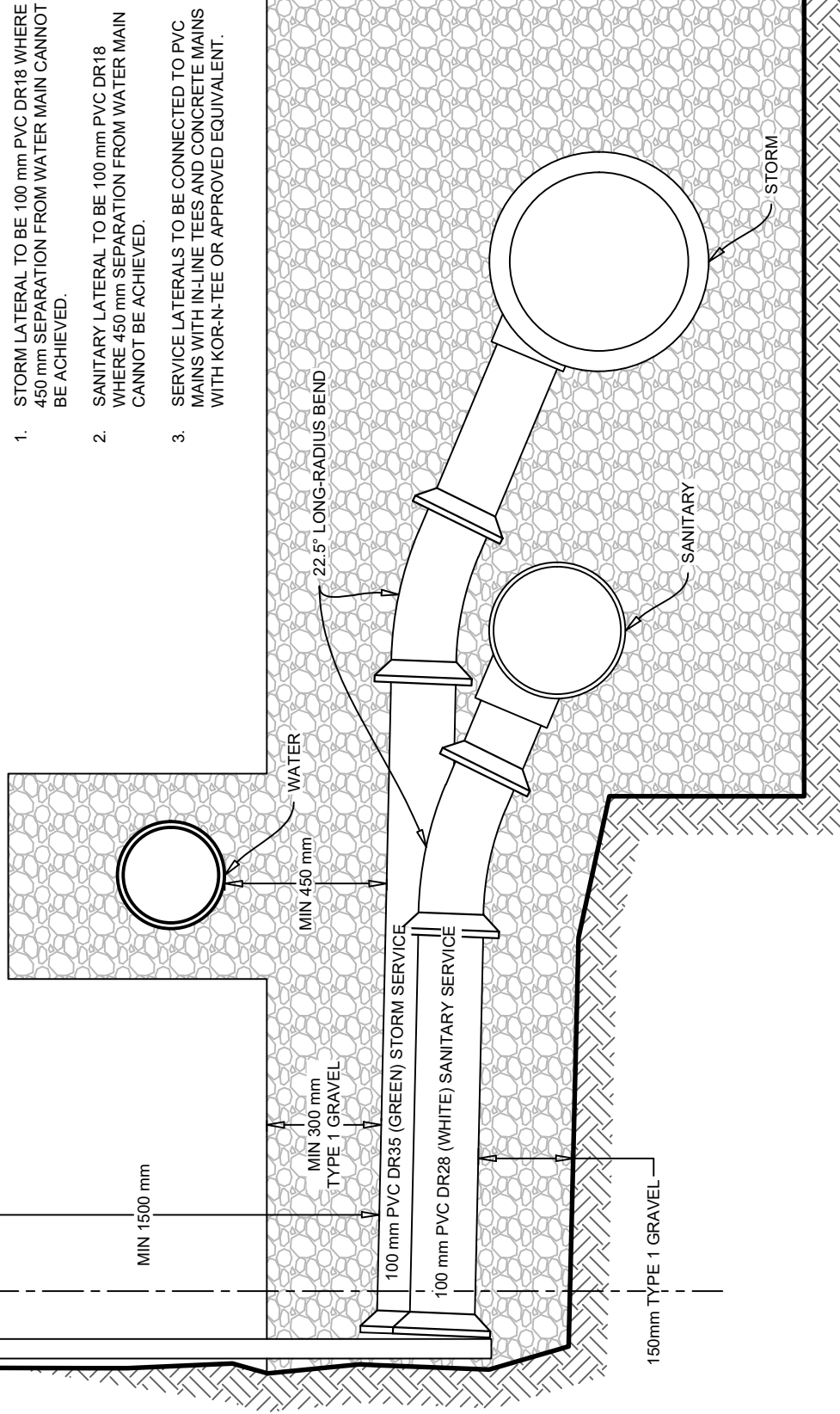

WEST HANTS REGIONAL MUNICIPALITY

STANDARD DETAIL

TYPICAL STORM AND SANITARY SERVICE LATERAL CROSS SECTION

DATE September 27, 2022

DRAWING NO. WH-24

SCALE

APPROVED

N.T.S.

| TRENCH GRADE | CLAY PLUG SPACING |
|--------------|-------------------|
| <0.5% | 600 m |
| 0.5% - 1.5% | 200 m |
| 1.5% - 2.5% | 120 m |
| 2.5% - 3.5% | 90 m |
| 3.5% - 10% | 30 m |
| >10% | 15 m |

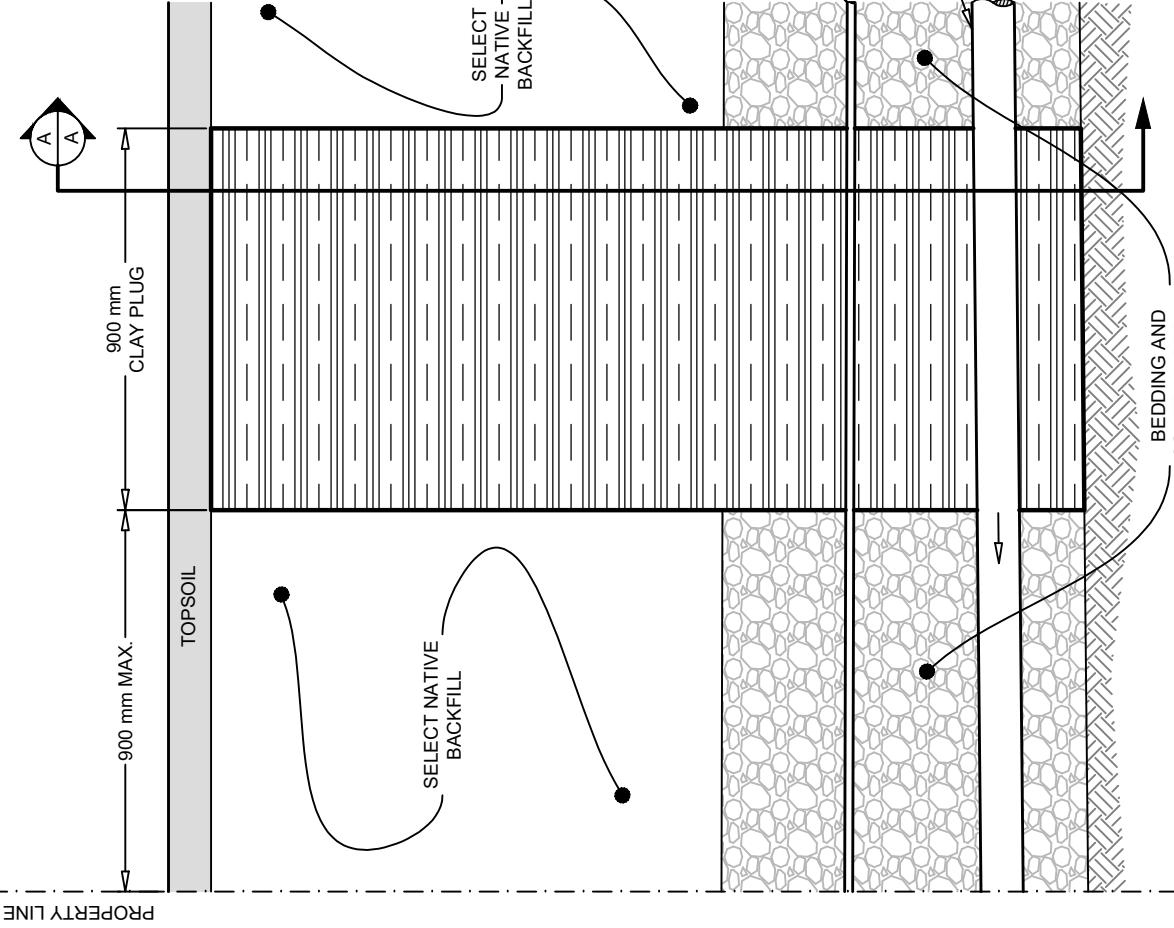

ELEVATION - CLAY PLUG

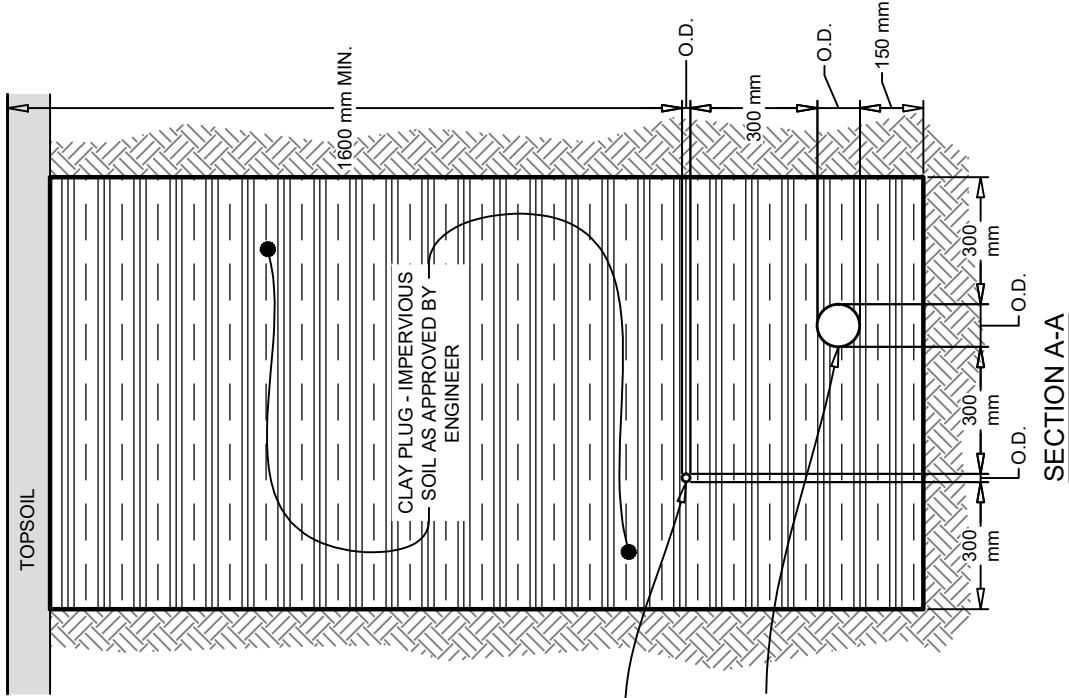

SECTION A-A

NOTES:

1. ALL DIMENSIONS ARE IN METRIC
2. WHERE NO WATER SERVICE IS TO BE INSTALLED, INSTALL SEWER LATERAL A MINIMUM OF 1200 mm BELOW DRIVEWAY OR STREET AND NOT LESS THAN 900 mm BELOW BOTTOM OF DITCH.
3. CLAY PLUGS TO BE INSTALLED IN TRENCHES AS REQUIRED BY THE MUNICIPALITY.



WEST HANTS REGIONAL MUNICIPALITY
STANDARD DETAIL
CLAY PLUG

| | | | | |
|-------------|--------------------|-------|----------|--------|
| DATE | September 27, 2022 | SCALE | APPROVED | N.T.S. |
| DRAWING NO. | WH-25 | | | |

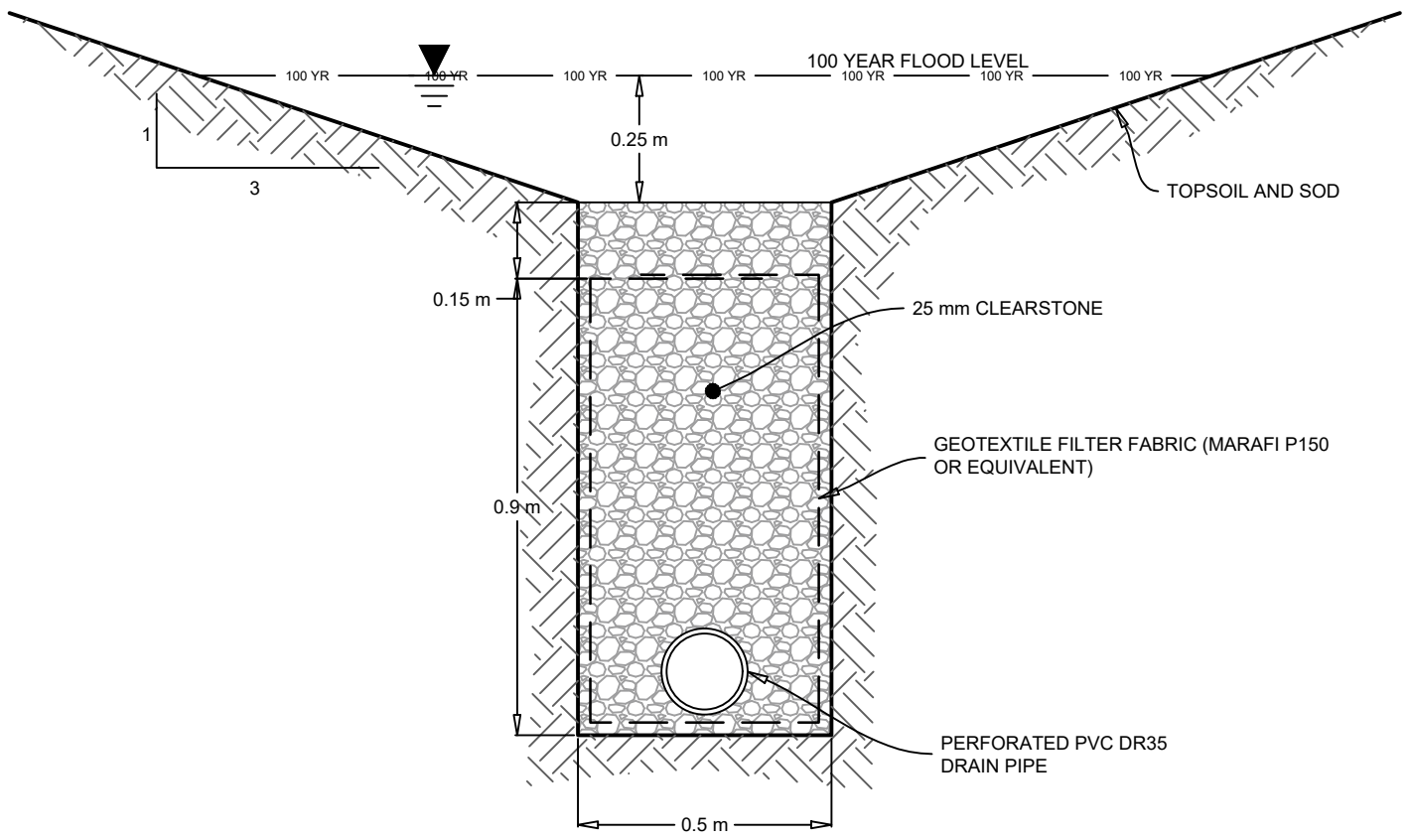

| | | | |
|---|--------------------|----------|--------|
| WEST HANTS REGIONAL MUNICIPALITY | | | |
| STANDARD DETAIL | | | |
| UNDER DRAIN | | | |
| DATE | September 27, 2022 | SCALE | N.T.S. |
| DRAWING NO. | WH-26 | APPROVED | |

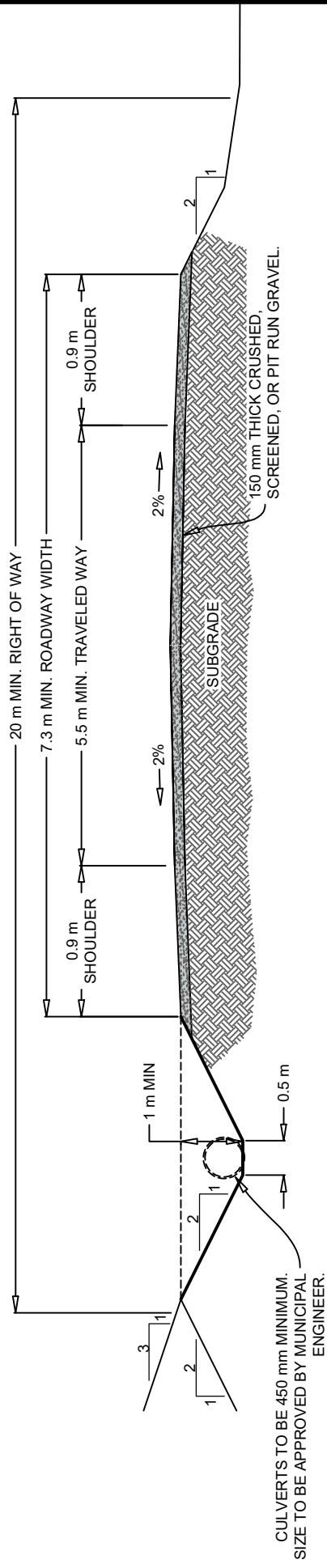

CULVERTS TO BE 450 mm MINIMUM. SIZE TO BE APPROVED BY MUNICIPAL ENGINEER.

NOTES:

1. SUBGRADE TO BE CLEAR OF ORGANIC MATERIAL TO A DEPTH OF 1.5 m
2. RIGHT OF WAY MAY BE REDUCED TO 15 m WIDE IF ALL ROAD BED, SLOPES, AND DITCHES CAN BE CONSTRUCTED WITHIN THE RIGHT OF WAY
3. CULVERTS TO BE CONCRETE OR HDPE AND PLACED 90° TO THE ROAD CENTERLINE AT 500 mm BELOW THE ROAD SURFACE.



| | | | |
|---|--------------------|----------|--------|
| WEST HANTS REGIONAL MUNICIPALITY | | | |
| STANDARD DETAIL | | | |
| PRIVATE ROAD CROSS SECTION | | | |
| DATE | September 27, 2022 | SCALE | N.T.S. |
| DRAWING NO. | WH-27 | APPROVED | |

SECTION B-B

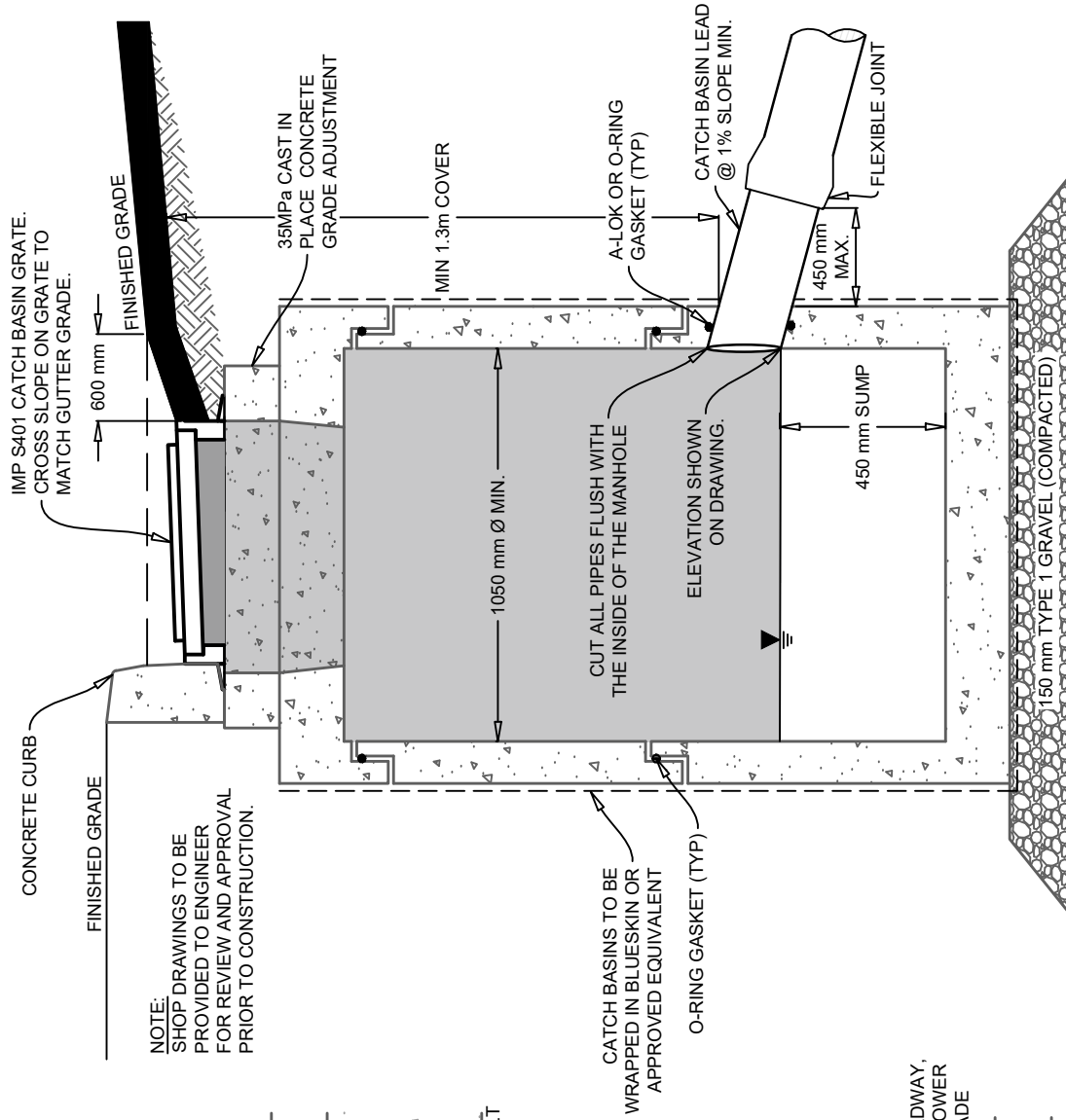

SECTION A-A

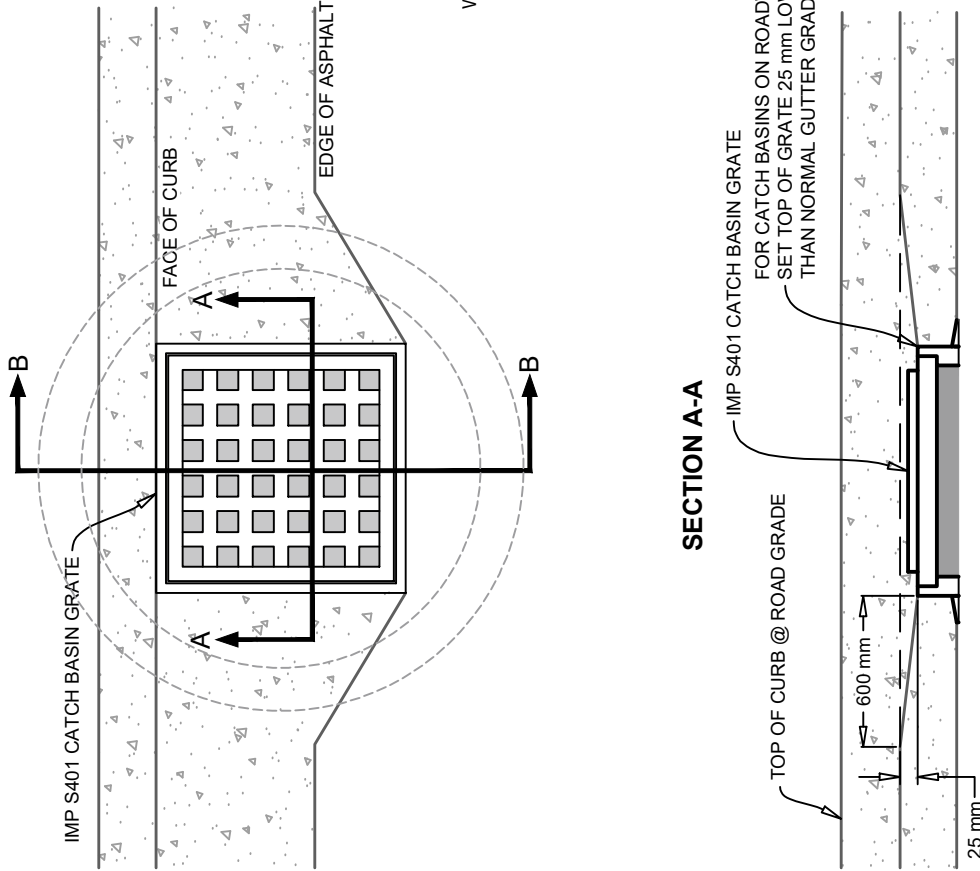

WEST HANTS REGIONAL MUNICIPALITY

STANDARD DETAIL

TYPICAL CATCH BASIN DETAIL

DATE January 16, 2023

DRAWING NO. WH-28

SCALE

APPROVED

N.T.S.

PLAN

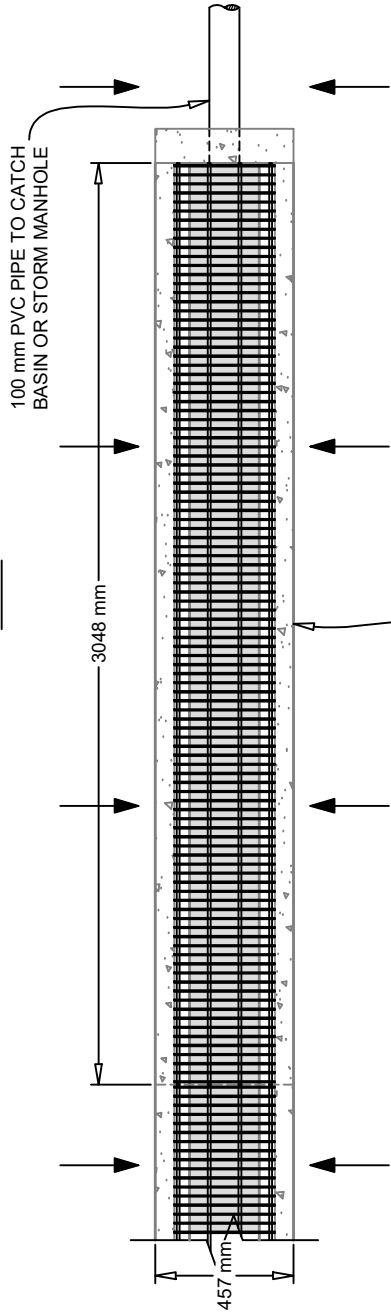

PRECAST CONCRETE TRENCH DRAIN WITH TRAFFIC RATED CL625 W102-30.57 X 4.8 BAR GRATING.

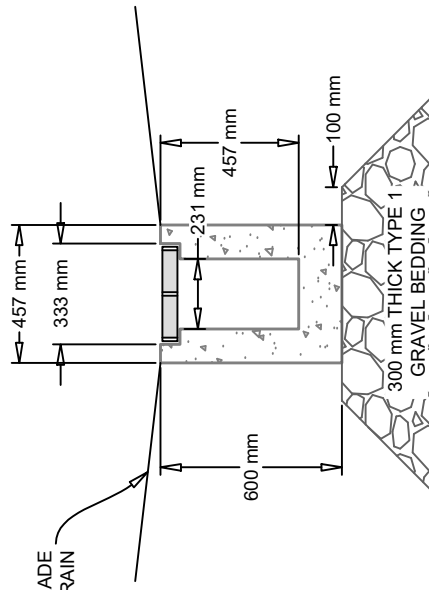

TYPICAL SECTION

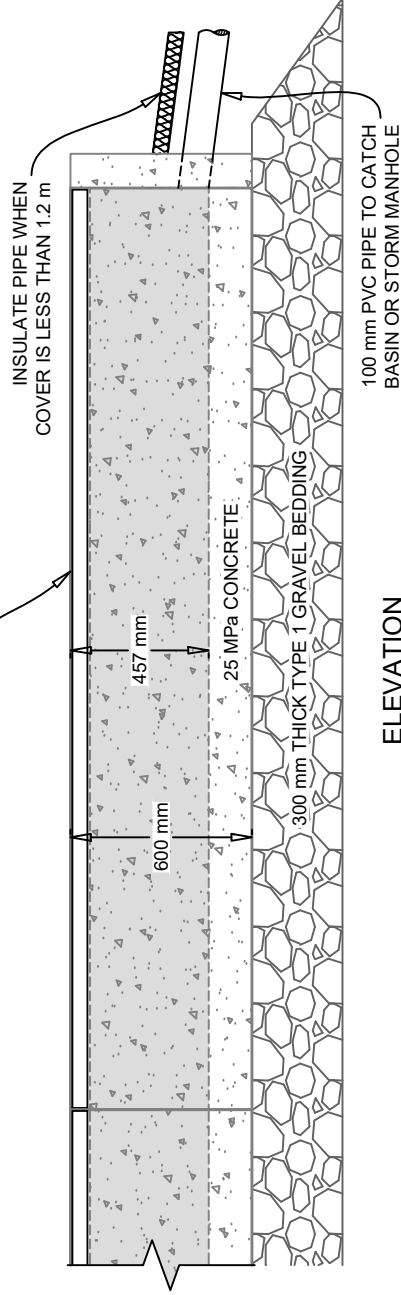

ELEVATION

NOTE:
TRENCH DRAIN SECTIONS TO BE CONNECTED WITH 10M REBAR DOWELS c/w EPOXY AND 300 mm EMBEDMENT. SHOP DRAWINGS TO BE SUBMITTED FOR PRECAST TRENCH DRAIN AND GRATE.



WEST HANTS REGIONAL MUNICIPALITY

STANDARD DETAIL

TRENCH DRAIN DETAIL

DATE January 16, 2023

DRAWING NO. WH-29

SCALE

APPROVED

N.T.S.

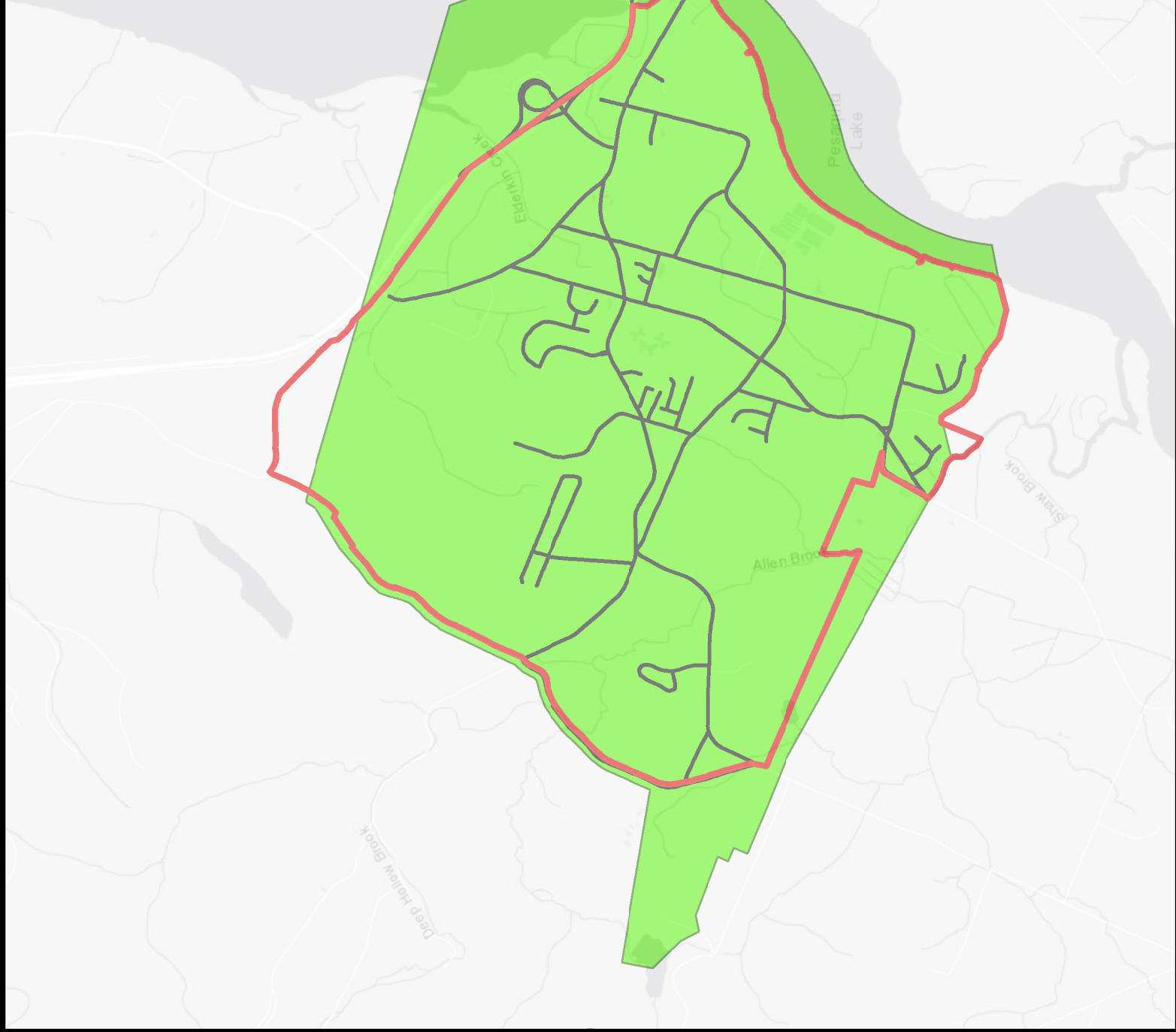
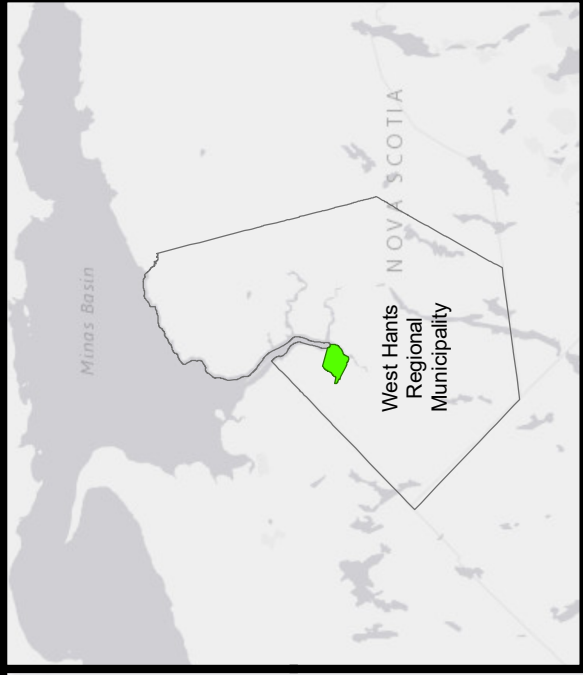

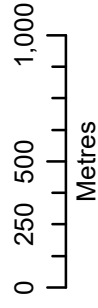

Falmouth, Nova Scotia

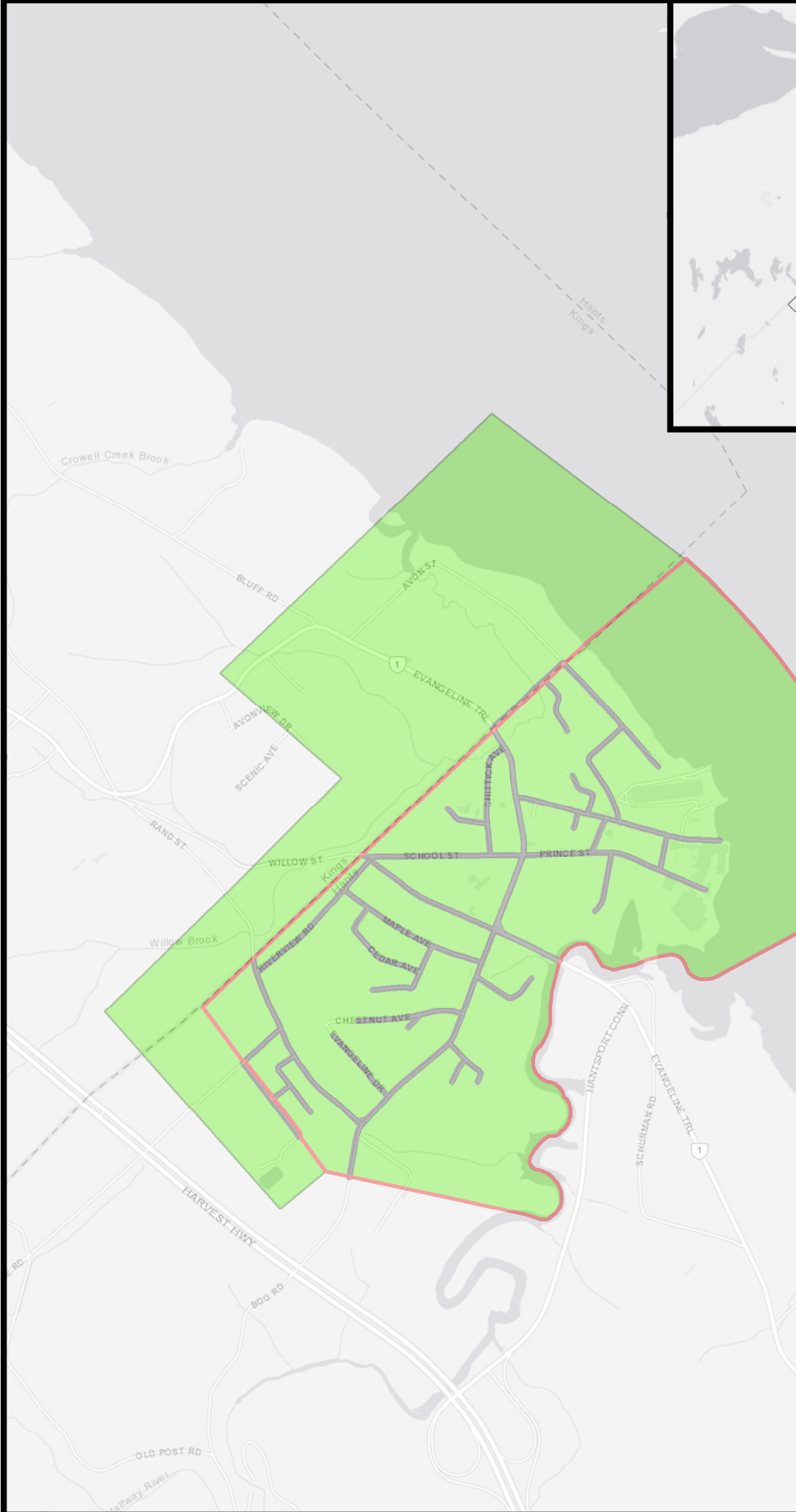

- Road (within Falmouth)
- ▭ Falmouth Boundary
- ▭ Serviced Area

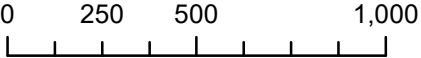

Hantsport, Nova Scotia



0 250 500 1,000
Metres

- Road (within Hantsport)
- ▭ Hantsport Boundary
- ▭ Serviced Area

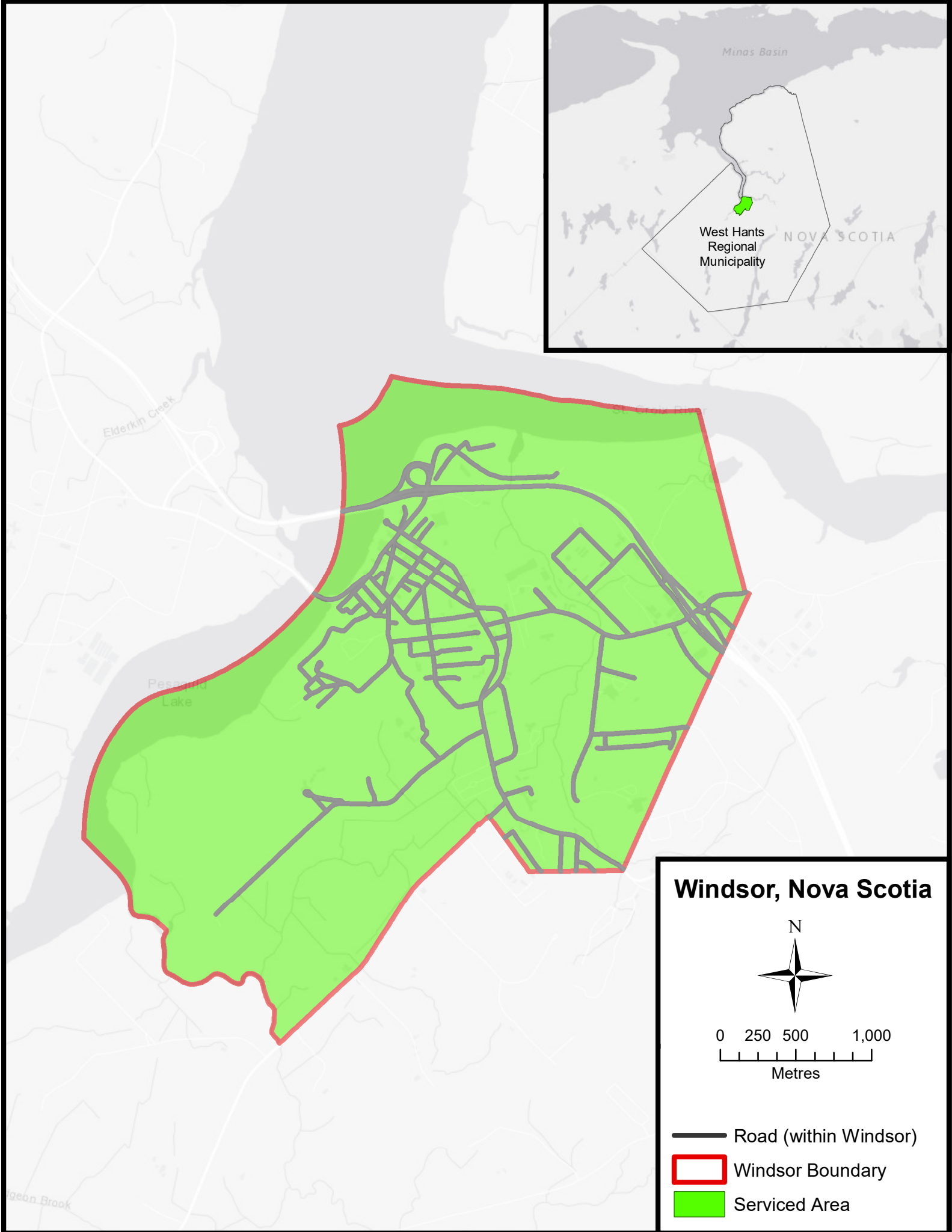

Minas Basin

West Hants
Regional
Municipality

NOVA SCOTIA

Elderkin Creek

Pessamind
Lake

Windsor, Nova Scotia



0 250 500 1,000
Metres

- Road (within Windsor)
- ▭ Windsor Boundary
- ▭ Serviced Area

Geon Brook

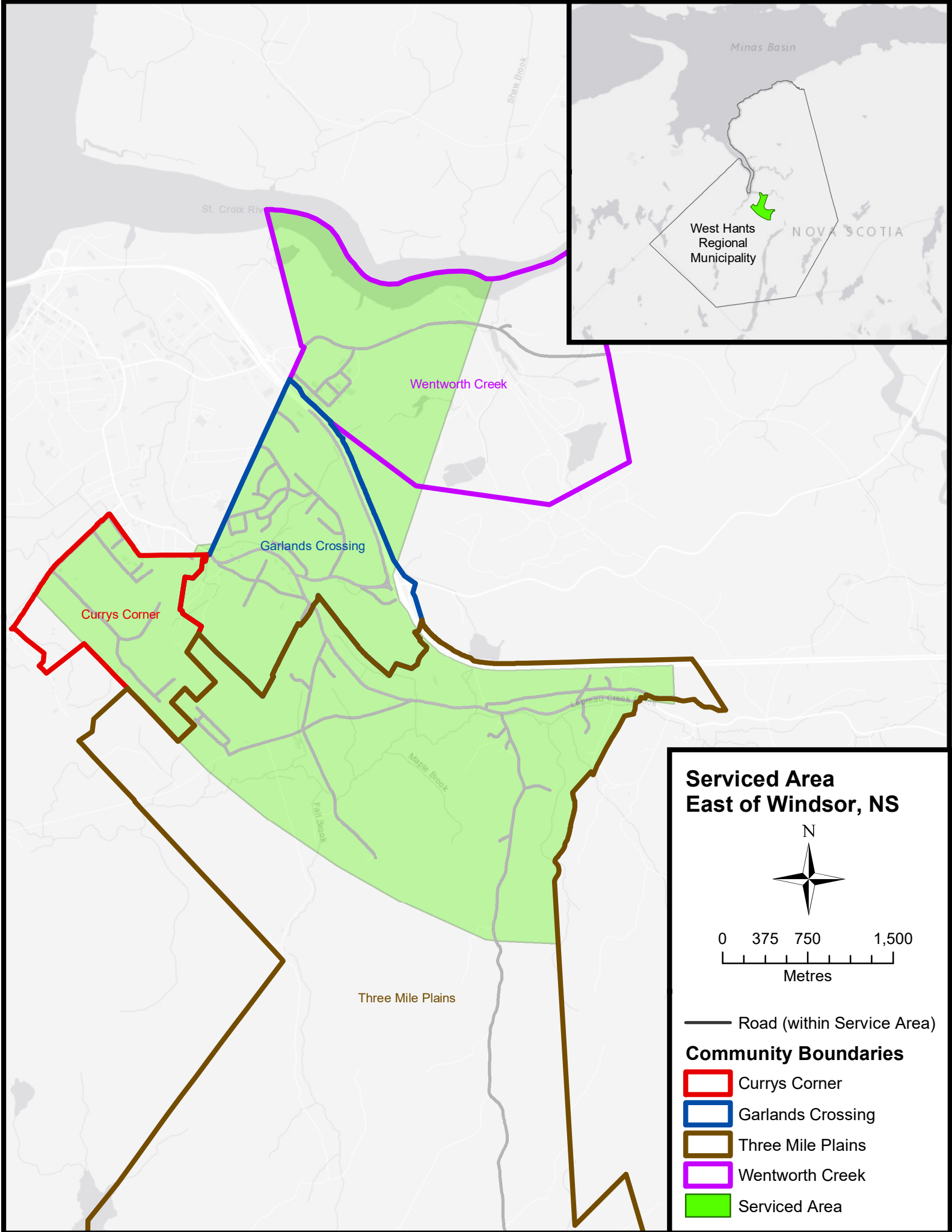

Minas Basin

St. Croix River

Shaw Brook

Wentworth Creek

Garlands Crossing

Currys Corner

Forest Creek

Maple Brook

Fall Brook

Three Mile Plains

Serviced Area East of Windsor, NS

N

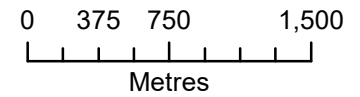

— Road (within Service Area)

Community Boundaries

-  Currys Corner
-  Garlands Crossing
-  Three Mile Plains
-  Wentworth Creek
-  Serviced Area